

SHARP®

MODEL

UX-470

FACSIMILE

OPERATION MANUAL

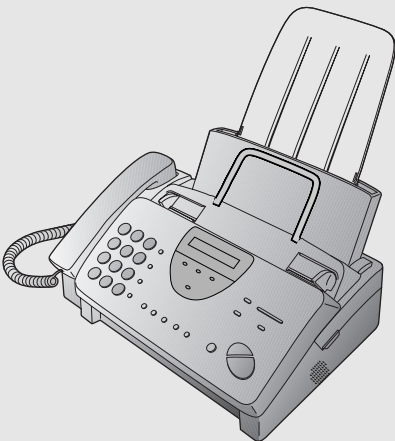

1. Installation
2. Using the Answering Machine
3. Sending Documents
4. Receiving Documents
5. Making Copies
6. Making Telephone Calls
7. Special Functions
8. Option Settings
9. Printing Reports and Lists
10. Maintenance
11. Troubleshooting

MAINS PLUG WIRING INSTRUCTIONS

This equipment is fitted with a moulded type mains plug which incorporates a detachable fuse cover, under no circumstances should the plug be used without the fuse cover fitted.

In the unlikely event of the socket outlet in your home not being compatible with the plug supplied, cut off the mains plug and fit an appropriate type observing the wiring code below.

DANGER: The fuse from the cut-off plug should be removed and the plug should be disposed of in a safe manner. Under no circumstances should the cut-off plug be inserted into a socket outlet as a serious electric shock may occur.

If you are not sure how to do this, get help from a qualified electrician.

IMPORTANT

The wires in this mains lead are coloured in accordance with the following code:

GREEN-AND-YELLOW:	Earth
BLUE:	Neutral
BROWN:	Live

As the colours of the wires in the mains lead of this apparatus may not correspond with the coloured markings identifying the terminals in your plug, proceed as follows:

The wire which is coloured **GREEN-AND-YELLOW** must be connected to the terminal in the plug which is marked by the letter **E**, or by the safety earth symbol \perp , or coloured green or green-and-yellow.

The wire which is coloured **BLUE** must be connected to the terminal which is marked with the letter **N** or coloured black.

The wire which is coloured **BROWN** must be connected to the terminal which is marked with the letter **L** or coloured red.

This apparatus must be protected by a 13A fuse in the mains plug or distribution board.

"WARNING: THIS APPARATUS MUST BE EARTHED"

This equipment complies with the requirements of Directives 89/336/EEC and 73/23/EEC as amended by 93/68/EEC. Dieses Gerät entspricht den Anforderungen der EG-Richtlinien 89/336/EWG und 73/23/EWG mit Änderung 93/68/EWG. Ce matériel répond aux exigences contenues dans les directives 89/336/CEE et 73/23/CEE modifiées par la directive 93/68/CEE.

Dit apparaat voldoet aan de eisen van de richtlijnen 89/336/EEG en 73/23/EEG, gewijzigd door 93/68/EEG.

Dette udstyr overholder kravene i direktiv nr. 89/336/EEC og 73/23/EEC med tillæg nr. 93/68/EEC.

Quest' apparecchio è conforme ai requisiti delle direttive 89/336/EEC e 73/23/EEC, come emendata dalla direttiva 93/68/EEC.

Η εγκατάσταση αυτή ανταποκρίνεται στις απαιτήσεις των οδηγιών της Ευρωπαϊκής Ένωσης 89/336/EOK και 73/23/EOK, όπως οι κανονισμοί αυτοί συμπληρώθηκαν από την οδηγία 93/68/EOK.

Este equipamento obedece às exigências das directivas 89/336/CEE e 73/23/CEE, na sua versão corrigida pela directiva 93/68/CEE.

Este aparato satisface las exigencias de las Directivas 89/336/CEE y 73/23/CEE, modificadas por medio de la 93/68/CEE.

Denna utrustning uppfyller kraven enligt riktlinjerna 89/336/EEC och 73/23/EEC så som kompletteras av 93/68/EEC.

Dette produktet oppfyller betingelsene i direktivene 89/336/EEC og 73/23/EEC i endringen 93/68/EEC.

Tämä laite täyttää direktiivien 89/336/EEC ja 73/23/EEC vaatimukset, joita on muutettu direktiivillä 93/68/EEC.

89/336/EEC : EMC directive 73/23/EEC : Low voltage directive 93/68/EEC : CE Mark regulation

This equipment is not designed for making emergency telephony calls when the power fails. Alternative arrangements should be made for access to emergency services.

Introduction

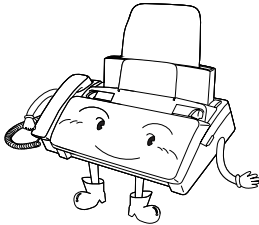

Welcome, and thank you for choosing a Sharp facsimile! The features and specifications of your new Sharp fax are shown below.

Automatic dialling

Rapid Key Dialling: 5 numbers
Speed Dialling: 40 numbers

Imaging film

Initial starter film (included with fax machine):
10 m roll (approx. 30 A4 pages)
Replacement film:
UX-3CR 30 m roll (two rolls in package, one roll yields approx. 95 A4 pages)

Automatic document feeder

10 sheets max.

Memory size*:

512 KB (approx. 30 average pages with no voice messages recorded, or 24 minutes of voice messages (including OGMs) with no documents in memory)

Modem speed

9600 bps with automatic fallback to 7200, 4800, or 2400 bps

Transmission time*

Approx. 15 seconds (Sharp special mode)

Reception modes

FAX, TEL, TEL/FAX, A.M.

Resolution

Horizontal:
8 lines/mm
Vertical:
Standard: 3.85 lines/mm
Fine/Halftone: 7.7 lines/mm
Super fine: 15.4 lines/mm

Note: The facsimile machine is Year 2000 compliant.

* Based on ITU-T Test Chart #1 at standard resolution in Sharp special mode, excluding time for protocol signals (i.e., ITU-T phase C time only).

Display	16-digit LCD display
Recording system	Thermal transfer recording
Halftone (greyscale)	64 levels
Applicable telephone line	Public switched telephone network / PBX
Compatibility	ITU-T (CCITT) G3 mode
Compression scheme	MH, MR, Sharp
Scanning method	Sheet-feeder CIS (Contact Image Sensor)
Effective printing width	204 mm max.
Input document size	Automatic feeding: Width: 148 to 210 mm Length: 140 to 297 mm Manual feeding: Width: 148 to 210 mm Length: 140 to 600 mm
Effective scanning width	210 mm max.
Contrast control	Automatic/Dark selectable
Copy function	Single/Multi-copy/Sort-copy (99 copies/page)
Telephone function	Standard (Cannot be used for incoming/outgoing if power fails)
Power requirements	230 V AC, 50 Hz
Operating temperature	5 to 35°C
Humidity	Maximum: 85 %
Power consumption	Stand-by: 3.0 W Maximum: 115 W
Dimensions	Width: 343 mm Depth: 313 mm Height: 312 mm
Weight	Approx. 3.4 kg

As a part of our policy of continuous improvement, SHARP reserves the right to make design and specification changes for product improvement without prior notice. The performance specification figures indicated are nominal values of production units. There may be some deviations from these values in individual units.

Important safety information

- Do not disassemble this machine or attempt any procedures not described in this manual. Refer all servicing to qualified service personnel.
- This machine must only be connected to a 230 V, 50 Hz, earthed (3-prong) outlet. Connecting it to any other kind of outlet may damage the machine.
- Do not install or use the machine near water, or when you are wet. Take care not to spill any liquids on the machine.
- Unplug the machine from the telephone socket and then the power outlet and consult a qualified service representative if any of the following situations occur:
 - Liquid has been spilled into the machine or the machine has been exposed to rain or water.
 - The machine produces odors, smoke, or unusual noises.
 - The power cord is frayed or damaged.
 - The machine has been dropped or the housing damaged.
- Do not allow anything to rest on the power lead, and do not install the machine where people may walk on the power lead.
- Never insert objects of any kind into slots or openings on the machine. This could create a risk of fire or electric shock. If an object falls into the machine that you cannot safely remove, unplug the machine and consult a qualified service representative.
- Do not place this machine on an unstable cart, stand or table. The machine could be seriously damaged if it falls.
- Never install telephone wiring during a lightning storm.
- Never install telephone sockets in wet locations unless the socket is specifically designed for wet locations.

- Never touch uninsulated telephone wires or terminals unless the telephone line has been disconnected at the network interface.
- Use caution when installing or modifying telephone lines.
- Avoid using a telephone (other than a cordless type) during an electrical storm. There may be a remote risk of electric shock from lightning.
- Do not use a telephone to report a gas leak in the vicinity of the leak.
- The socket-outlet must be installed near the equipment and must be easily accessible.

Important:

- This facsimile machine is not designed for use on a line which has call waiting, call forwarding, or certain other special services offered by your telephone company. If you attempt to use the fax machine on a telephone line using any of these services, you may experience errors during transmission and reception of facsimile messages.
- This facsimile machine is not compatible with digital telephone systems.

Regulatory information

- ◆ This facsimile machine is only designed to operate in the country where approved.

Your Sharp UX-470 Facsimile Transceiver is approved for connection to the Public Switched Telephone Network (PSTN), it is also approved for connection via a Private Branch Exchange (PBX), and can be used with either Loop Disconnect (LD) or Dual Tone Multi-Frequency (DTMF) signalling.

Your facsimile machine is not suitable as an extension to some payphones or for use on shared service lines.

REN

The Ringer Equivalence Number (REN) of your fax machine is 1.

The total number of instruments that can be connected to an exclusive line is determined by adding the REN values of each instrument. The total should not exceed 4.0. A telephone provided by BT is assumed to have a REN of 1 unless otherwise marked.

Satisfactory ringer operation can not be guaranteed in installations consisting of mixed apparatus types, even if the REN value does not exceed 4.

Emergency services

Emergency services (999) can be called from this apparatus. Please display on the telephone the number required to access that service, together with the number of the telephone, using the label provided.

◆ Private branch exchange (PBX) connection

Your facsimile machine is approved for connection to the Public Telephone Network (PSTN) via compatible PBX systems. Consult your supplier for a list of suitable PBX systems. It cannot be guaranteed that this facsimile machine will operate correctly under all possible conditions of connection to compatible PBX systems.

This facsimile machine has been approved for use of the following facilities:

Simple telephone

Tone dialling (DTMF)

Loop disconnect (Pulse dialling)

Memory dialling

Loudspeaking (Call Progress Monitor)

On-hook dialling

Automatic answering

Automatic dialling

Automatic clearing

Last number redial

Time break or Earth recall

Series connection of extension telephone(s)

Any other usage will invalidate the approval of the facsimile if as a result it then ceases to comply with the standards against which approval was granted.

Series connection

When connected via series apparatus, difficulties may occasionally be experienced when making calls to the PSTN and by both parties during telephone conversations. If difficulties are experienced, contact the supplier or maintainer of the series apparatus in the first instance.

While operation may be possible initially, changes to or modernisation of the network taking place in the normal course of events may result in the facsimile equipment being connected to a network service with which it was not designed to be compatible. Failure of the facsimile / series apparatus to work under these circumstances may not be the fault of the network operator.

The voltage drop introduced by your facsimile between the PSTN and the associated apparatus at a current of 40mA d.c. is 2 volts, therefore no additional series equipment may be connected.

Table of Contents

1	Installation	9
	Unpacking Checklist	9
	A Look at the Operation Panel	10
	Connections	13
	Loading the Imaging Film	19
	Loading Printing Paper	24
	Entering Your Name and Fax Number	26
	Setting the Date and Time	29
	Selecting the Reception Mode	32
	Volume Adjustment	34
2	Using the Answering Machine	36
	Recording an Outgoing Message	36
	Operating the Answering Machine	39
	Recording Memos and Telephone Conversations	41
	Optional Answering Machine Settings	43
	Transfer Function	47
	Override Ringing	50
	Remote Operations	52
3	Sending Documents	61
	Transmittable Documents	61
	Loading the Document	63
	Resolution and Contrast	65
	Sending a Fax by Normal Dialling	67
	Sending a Fax by Automatic Dialling	69
4	Receiving Documents	78
	Using TEL/FAX Mode	78
	Using FAX Mode	79
	Using A.M. Mode	80
	Using TEL Mode	81
	Substitute Reception to Memory	85

5	Making Copies	86
6	Making Telephone Calls	89
7	Special Functions	93
	Caller ID	93
	Broadcasting	98
	Cover Sheet	100
	Batch Page Numbering	103
	Blocking Reception of Unwanted Faxes	105
	Sending Documents From Memory	107
	Polling (Requesting a Fax Transmission)	109
	Timer Operations	112
8	Option Settings	114
9	Printing Reports and Lists	121
10	Maintenance	128
11	Troubleshooting	132
	Problems and Solutions	132
	Messages and Signals	136
	Clearing Paper Jams	139
	Quick Reference Guide	142
	Index	144

Installation

Unpacking Checklist

Before setting up, make sure you have all of the following items.



If any are missing, contact your dealer or retailer.

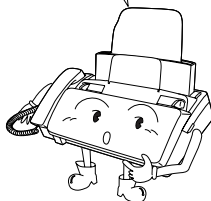

Original document support

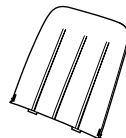

Paper tray extension

Handset



Rapid key labels



Handset lead

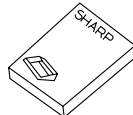
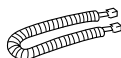

Operation manual

Gears (4)

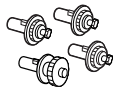

Telephone line cord



Imaging film (initial starter roll)

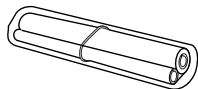

Imaging film cartridge

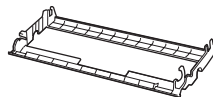

Emergency labels



A Look at the Operation Panel

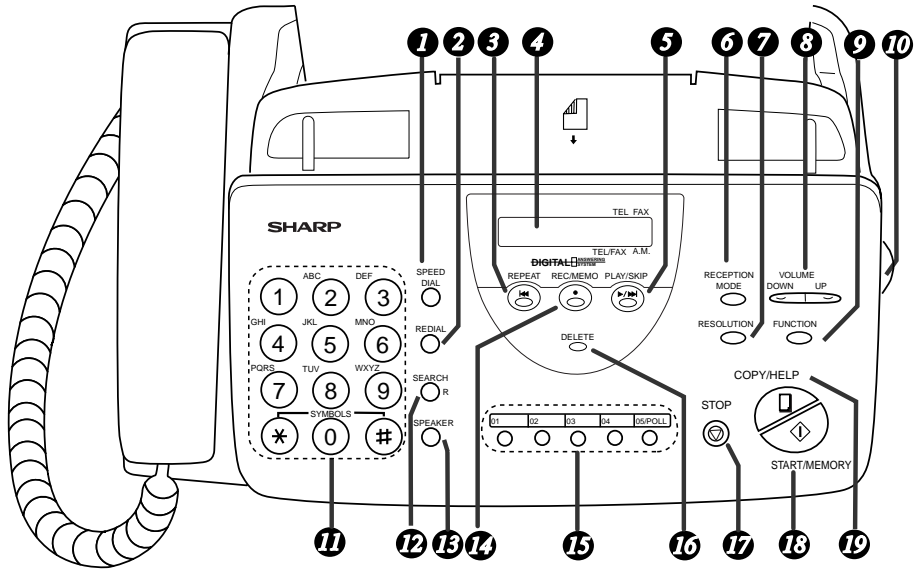

- 1 SPEED DIAL key**
Press this key to dial a 2-digit Speed Dial number.
- 2 REDIAL key**
Press this key to automatically redial the last number dialed.
- 3 REPEAT key**
Press this key to repeat playback of a message.
- 4 Display**
This displays messages and prompts during operation and programming.
- 5 PLAY/SKIP key**
Press this key to play recorded messages. During playback, press it to skip forward to the next message.

- 6 RECEPTION MODE key**
Press this key to select the reception mode. An arrow in the display will point to the currently selected reception mode.
- 7 RESOLUTION key**
Press this key to adjust the resolution and contrast before sending or copying a document.
- 8 VOLUME keys**
Press these keys to adjust the volume of the speaker when the **SPEAKER** key has been pressed, or the volume of the ringer at all other times.
- 9 FUNCTION key**
Press this key to select various special functions.
- 10 Panel release**
Grasp this finger hold and pull toward you to open the operation panel.
- 11 Number keys**
Use these keys to dial numbers, and enter numbers and letters during number/name storing procedures.
- 12 SEARCH/R key**
Press this key to search for an automatic dialling number, or, if you are on a P.B.X. extension, press this key to transfer a call.
- 13 SPEAKER key**
Press this key to hear the line and fax tones through the speaker before sending a document, or dialling a voice number.
Note: **This is not a speakerphone.** You must pick up the handset to talk with the other party.
- 14 REC/MEMO key**
Press this key to record a phone conversation or a message.
- 15 Rapid Dial Keys**
Press one of these keys to dial a fax or voice number automatically. (Note that you must attach the Rapid Key labels.)

16 DELETE key

Press this key to erase recorded messages.

17 STOP key

Press this key to cancel operations before they are completed.

18 START/MEMORY key

Press this key to send or receive a document, or to scan a document into memory before sending it.

19 COPY/HELP key

When a document is in the feeder, press this key to make a copy. At any other time, press this key to print out the Help List, a quick reference guide to the operation of your fax.

Connections

Points to keep in mind when setting up

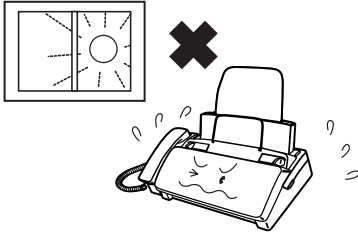

Do not place the machine in direct sunlight.

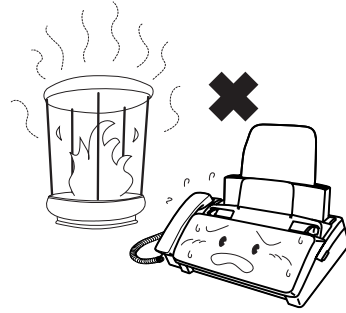

Do not place the machine near heaters or air conditioners.

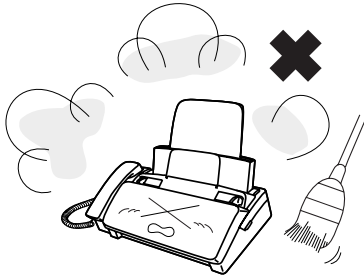

Keep dust away from the machine.

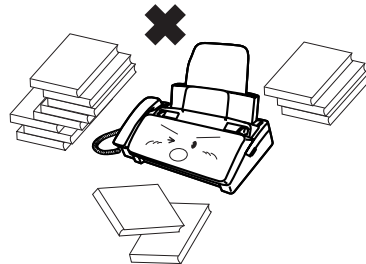

Keep the area around the machine clear.

About condensation

If the machine is moved from a cold to a warm place, it is possible that condensation may form on the scanning glass, preventing proper scanning of documents for transmission. To remove the condensation, turn on the power and wait approximately two hours before using the machine.

Handset

Connect the handset as shown and place it on the handset rest.

- ◆ The ends of the handset lead are identical, so they will go into either socket.

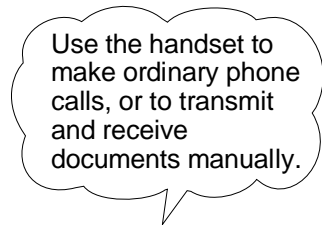
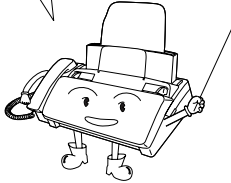
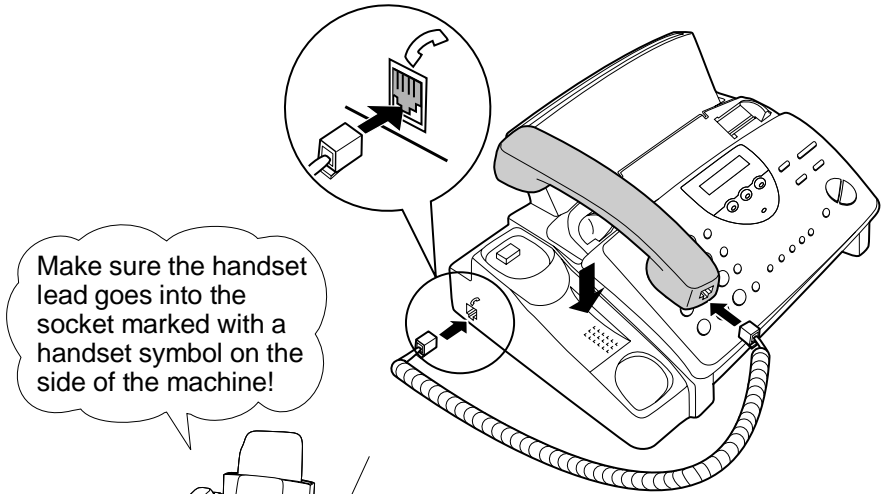

Power lead

Plug the power lead into a 230 V, 50 Hz, earthed (3-prong) AC outlet.

Caution: The mains outlet (socket outlet) should be installed near the equipment and be easily accessible.

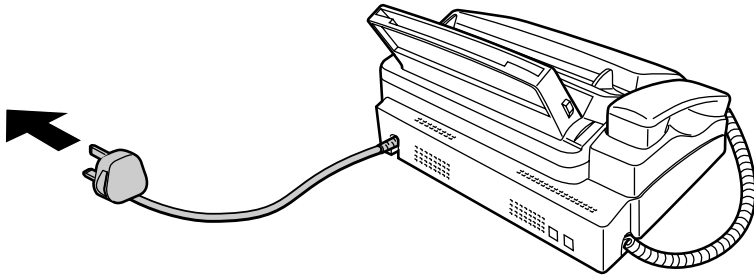

The machine does not have a power on/off switch, so the power is turned on and off by simply plugging or unplugging the power lead.

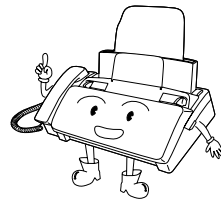

Note: If your area experiences a high incidence of lightning or power surges, we recommend that you install surge protectors for the power and telephone lines. Surge protectors can be purchased from your dealer or at most telephone specialty stores.

Telephone line cord

Insert one end of the line cord into the socket on the back of the machine marked **TEL. LINE**. Insert the other end into a wall telephone socket.

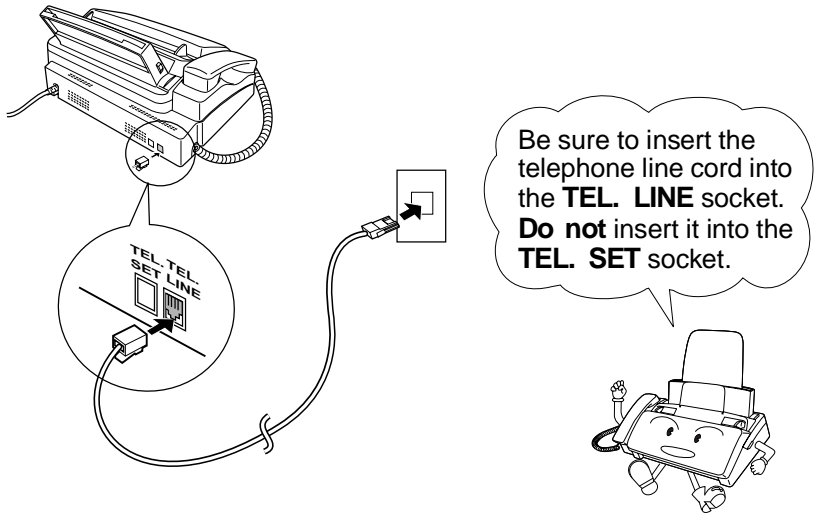

Comments:

- Your fax is set for tone dialling. If you are on a pulse only dial line, you must set the fax for pulse dialling by changing Option Setting 9. This procedure is described in Chapter 8, *Option Settings*.
- If you are connecting the fax to a PBX, you may need to reset the fax to the appropriate recall mode for the PBX. This is done by setting Option Setting 11 as described in Chapter 8.
- If you intend to use a computer fax modem on the same phone line, you must reset Option Setting 12 (Fax Signal Receive) to NO in order to prevent transmission and reception errors. This procedure is described in Chapter 8, *Option Settings*.
- The facsimile machine will not ring in response to incoming calls and cannot be used to make outgoing calls in the absence of mains power to the machine. For this reason it is recommended that the fax is not left as the only telephone instrument on line when in this state.
- Your fax cannot be used on a key system without the necessary adaptation of the system. Please consult the installers of the system if this is required.

Trays

Attach the paper tray extension.

- ◆ Pull the paper release plate forward. Insert the paper tray extension horizontally into the notches in the paper tray. Rotate the paper tray extension up until it snaps into place.

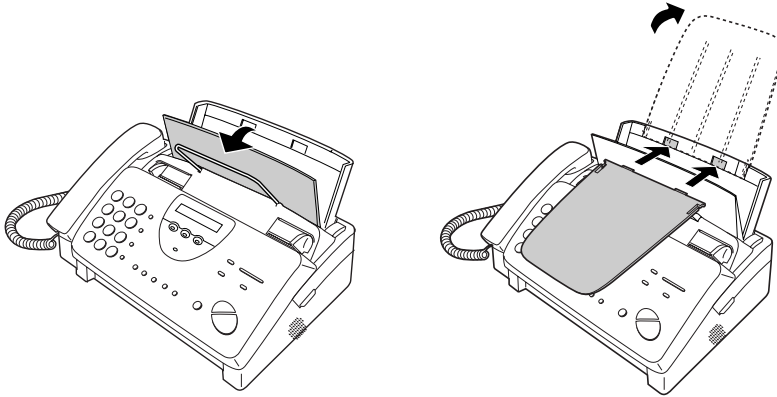

Attach the original document support.

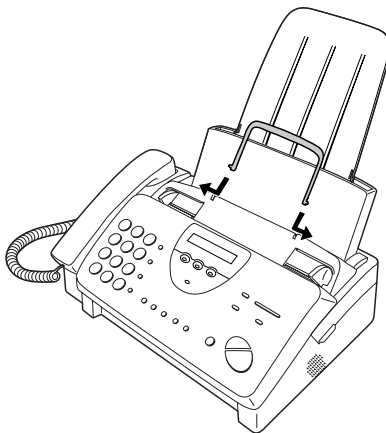

Note: The original document support has a top side and a bottom side. If you cannot insert the tabs on the support into the holes, turn the support over.

Other devices

If desired, you can connect an extension telephone to the same line as your fax. This can be used to make and receive calls as normal. For details on initiating the receipt of faxes from an extension phone, see "Receiving Documents" in Chapter 4.

Comments:

- More than one extension telephone may be connected to the same line as the fax, provided the total REN value does not exceed 4.
- The **TEL.SET** socket (sealed with a protective cover) has been provided on the back of the unit. The safety status of this socket is TNV, and is provided for the connection of approved telephone equipment only where appropriate. To ensure continued safety compliance, do not connect any other equipment to this socket.

Loading the Imaging Film

Your fax uses a roll of imaging film to create printed text and images. The print head in the fax applies heat to the imaging film to transfer ink to the paper. Follow the steps below to load or replace the film.

The initial starter roll of imaging film included with your fax can print about 30 A4 pages.



When replacing the film, use a roll of Sharp UX-3CR imaging film. One roll can print about 95 A4 pages.

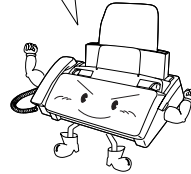

Note: If there is paper in the paper tray, pull the paper release plate forward and remove the paper before loading the imaging film.

- 1 Open the operation panel by grasping the finger hold and pulling up.

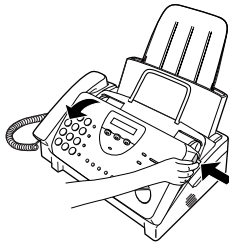

- 2 Pull the green release on the right side of the machine forward, and open the print compartment cover.

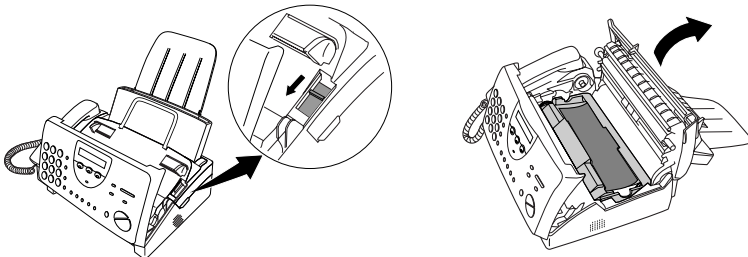

If you are installing the imaging film for the first time, go to Step 6.

- 3** Remove the imaging film cartridge from the print compartment (grasp the handle at the front of the cartridge) and turn it over.

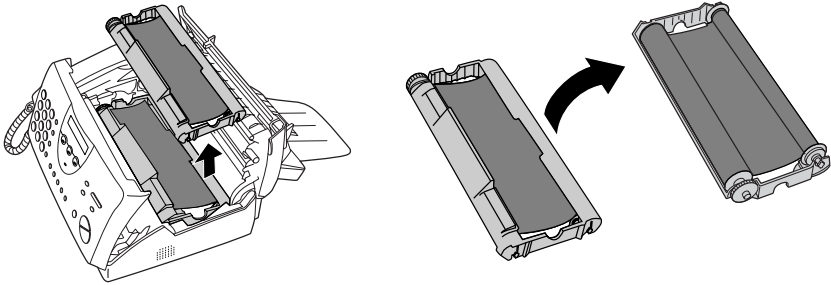

- 4** Remove the used film from the cartridge.

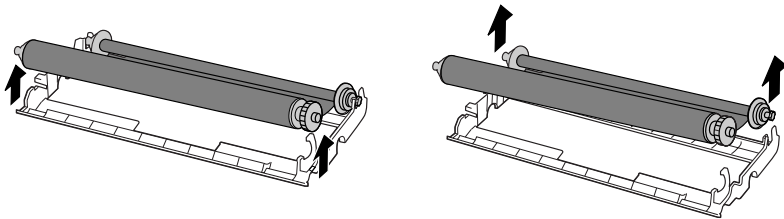

- 5** Remove the four green gears from the used film.
DO NOT DISCARD THE FOUR GREEN GEARS!

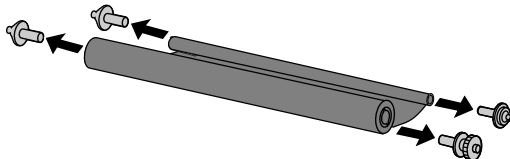

- 6** Remove the new roll of imaging film from its packaging.
- Do not yet remove the band that holds the rolls together.

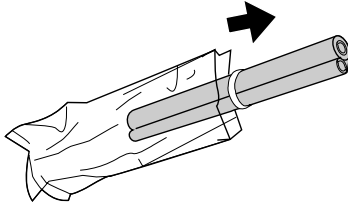

- 7** Insert the large gear into the green end of the empty spool. Make sure the two protrusions on the large gear fit firmly into the slots in the end of the spool.

Insert the remaining three gears into the spools, making sure the protrusion on each gear fits firmly into one of the slots in the end of each spool.

- If needed, pull the spools apart slightly to allow the gears to fit (the band will stretch).

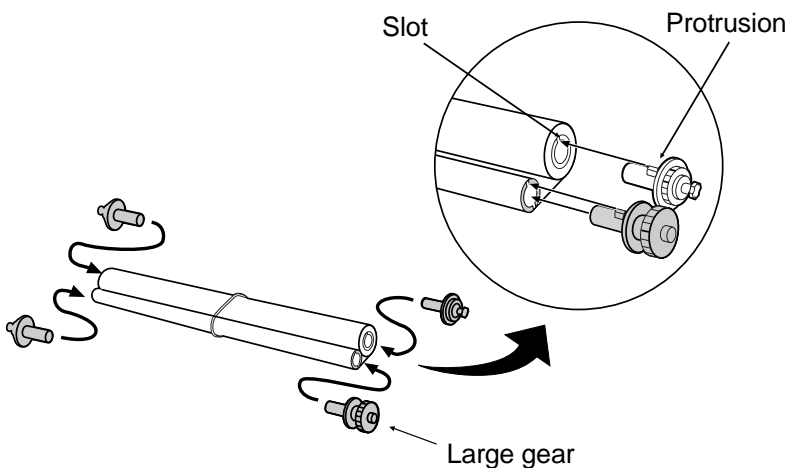

- 8** Insert the large gear into the large holder on the imaging film cartridge (make sure it clicks into place), and then insert the small gear on the other end of the spool into its holder.

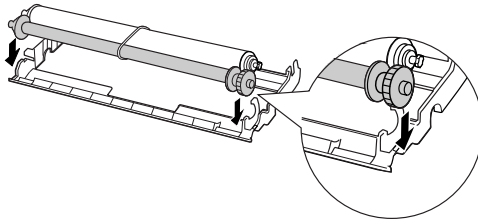

- 9** Cut the band that holds the two spools together. Unroll the film slightly and insert the small gears into their holders.

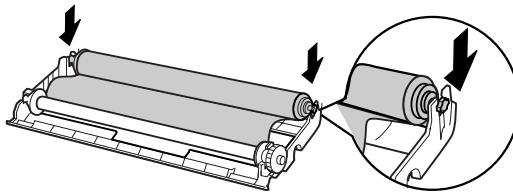

- 10** Turn the cartridge over, grasp the handle, and insert the cartridge into the print compartment.

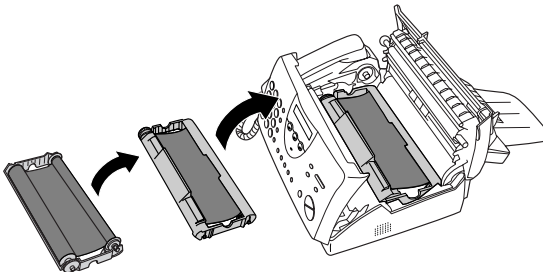

- 11** Rotate the large gear toward you until the film is taut.

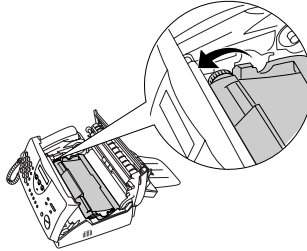

- 12** Gently close the print compartment cover (press down on both sides to make sure it clicks into place), and then close the operation panel.

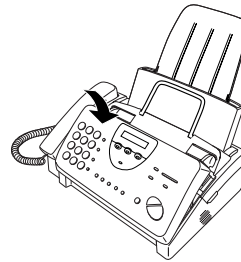
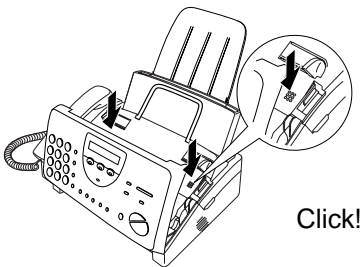

- 13** Load paper in the paper tray and then press the following keys to initialize the film.

Note: Paper must be loaded before the film can be initialized. To load paper, see the following section, *Loading the Printing Paper*.

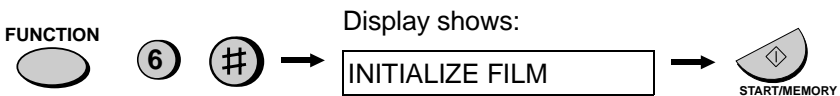

When to replace the imaging film

Replace the imaging film when the display shows:

FILM END

Use the following imaging film, which is available from your dealer or retailer:

Sharp UX-3CR Imaging Film

Loading Printing Paper

You can load A4 size paper in the paper tray. The maximum number of sheets is:

- ◆ 60 for paper from 60 to 75 g/m²
- ◆ 50 for paper from 75 to 90 g/m²

-
- 1** Fan the paper, and then tap the edge against a flat surface to even the stack.

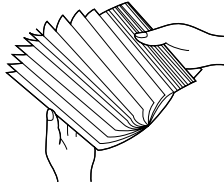

-
- 2** Pull the paper release plate toward you.

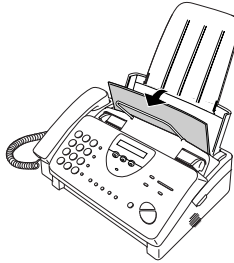

-
- 3** Insert the stack of paper into the tray, **print side down**.

- If paper remains in the tray, take it out and combine it into a single stack with the new paper before adding the new paper.

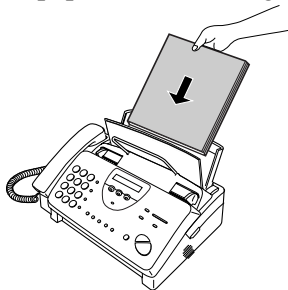

Be sure to load the paper so that printing takes place on the **print** side of the paper. Printing on the reverse side will result in poor print quality.

- 4** Push the paper release plate back down.

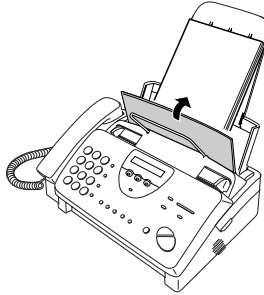

If the paper release plate is not pushed down, paper feed errors will result.

Note: When receiving faxes or copying documents, do not allow a large number of pages to accumulate in the output tray. This may obstruct the outlet and cause paper jams.

- 5** Your fax has been set at the factory to print at normal contrast. Depending on the type of paper you have loaded, you may find that you obtain better print quality by changing the setting to **LIGHT**. Press these keys:



The display will show: PRINT CONTRAST

Press **1** to select **NORMAL** or **2** to select **LIGHT**.

NORMAL LIGHT
1 or 2

The display will show: COPY CUT-OFF

Press the **STOP** key to return to the date and time display.



Entering Your Name and Fax Number

Before you can begin using your fax, you need to enter your name and the telephone number of your fax. You also need to set the date and time.



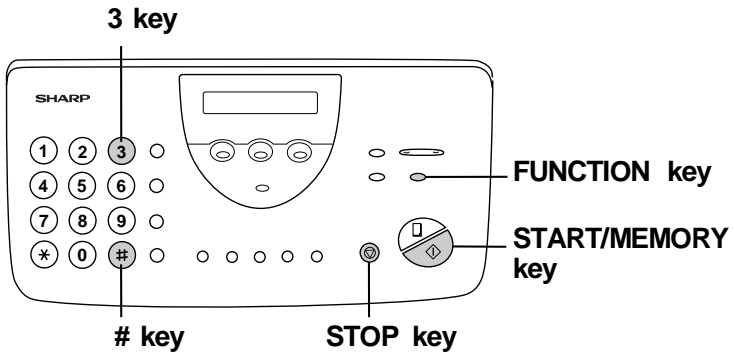
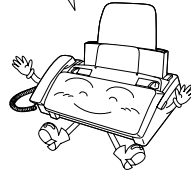

Once you enter this information, it will automatically appear at the top of each fax page you send.



Note: The imaging film and printing paper must be loaded before your name and fax number can be entered.

- 1** Press these keys:  → 

The display will show:

- 2** Press the # key twice:  

The display will show:

- 3** Press the **START/MEMORY** key.



The display will show: ENTER FAX #

- 4** Enter your fax number by pressing the number keys. Up to 20 digits can be entered.
- To insert a space between digits, press the # key. To insert a "+", press the * key.
 - If you make a mistake, press the **SEARCH/R** key to move the cursor back to the mistake and then enter the correct number. The new number will replace the old number.

Example: (5) (5) (5) (#) (1) (2) (3) (4)

Cursor: A dark square mark in the display that indicates where a number or letter will be entered.

- 5** Press the **START/MEMORY** key to enter the fax number in memory.



The display will show: ENTER YOUR NAME

- 6** Enter your name by pressing the number keys as shown in the following chart. Up to 24 characters can be entered.
- To enter two letters in succession that require the same key, press the **SPEAKER** key after entering the first letter to advance the cursor.

Example: SHARP = 7 7 7 7 7 4 4 4 2 2 7 7 7 7  7 7

Entering Your Name and Fax Number

A = (2) (2)	J = (5) (5)	S = (7) (7) (7) (7) (7)
B = (2) (2) (2)	K = (5) (5) (5)	T = (8) (8)
C = (2) (2) (2) (2)	L = (5) (5) (5) (5)	U = (8) (8) (8)
D = (3) (3)	M = (6) (6)	V = (8) (8) (8) (8)
E = (3) (3) (3)	N = (6) (6) (6)	W = (9) (9)
F = (3) (3) (3) (3)	O = (6) (6) (6) (6)	X = (9) (9) (9)
G = (4) (4)	P = (7) (7)	Y = (9) (9) (9) (9)
H = (4) (4) (4)	Q = (7) (7) (7)	Z = (9) (9) (9) (9) (9)
I = (4) (4) (4) (4)	R = (7) (7) (7) (7)	SPACE = (1) (1)

			← Press this key to delete the letter highlighted by the cursor.
			← Press this key to change case.
			← Press this key to move the cursor to the left.
			← Press this key to move the cursor to the right.

Press either key repeatedly to select one of the following symbols:
 ./!"#\$%&'()*+,-;=<=>?@[¥]^_`{|}~<->

7 Press the **START/MEMORY** key to save your name in memory.



The display will show: SECURITY SELECT

8 Press the **STOP** key to return to the date and time display.



Setting the Date and Time

The date and time appear in the display and reports, and are printed at the top of every page you fax.

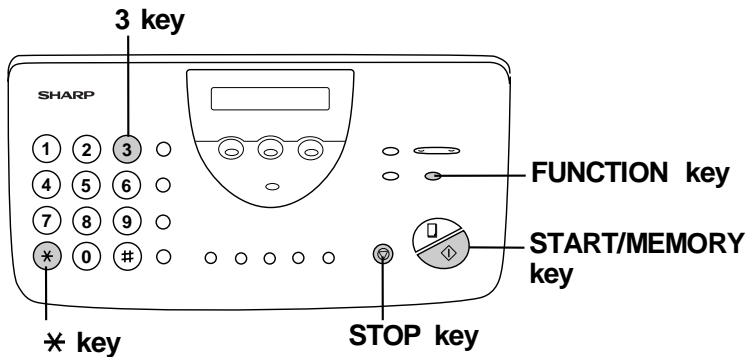
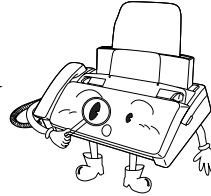

Note: The imaging film and printing paper must be loaded before the date and time can be set.

1 Press these keys:

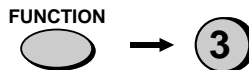

The display will show: ENTRY MODE

2 Press the * key three times.



The display will show: DATE & TIME SET

Note: The fax is Year 2000 compliant.

3 Press the **START/MEMORY** key.



- The currently set date will appear in the display.

4 Enter a two-digit number for the day ("01" to "31").

- To correct a mistake, press the **SPEED DIAL** key to move the cursor back to the mistake, and then enter the correct number.

Example: the 5th



5 Enter a two-digit number for the month ("01" for January, "02" for February, "12" for December, etc.).

Example: January



6 Enter the year (four digits).

Example: 1999



7 Enter a two-digit number for the hour ("00" to "23") and a two-digit number for the minute ("00" to "59").

Example: 9:25



-
- 8** Press the **START/MEMORY** key to start the clock.



The display will show: STORE JUNK #

-
- 9** Press the **STOP** key to return to the date and time display.



Selecting the Reception Mode

Your fax machine has four modes for receiving incoming calls and faxes:

TEL mode:

This mode is the most convenient for receiving phone calls. Faxes can also be received; however, all calls must first be answered by picking up the fax's handset or an extension phone connected to the same line.

FAX mode:

Select this mode when you only want to receive faxes on your line. The fax machine will automatically answer all calls and receive incoming faxes.

TEL/FAX mode:

This mode is convenient for receiving both faxes and voice calls. When a call comes in, the fax will detect whether it is a voice call (including manually dialed fax transmissions), or an automatically dialed fax. If it is a voice call, the fax will make a special ringing sound to alert you to answer. If it is an automatically dialed fax transmission, reception will begin automatically.

A.M. mode:

Select this mode when you are out and want the built-in answering machine to answer all calls. Voice messages will be recorded, and fax messages will be received automatically.

Setting the reception mode

Press the **RECEPTION MODE** key until the arrow in the display points to the desired mode.

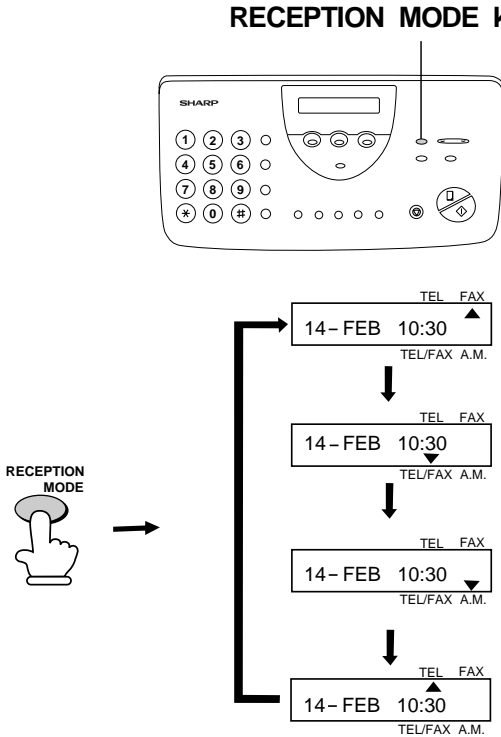

Note: A.M. mode cannot be selected unless a general outgoing message has been recorded as explained in Chapter 2.

For more information on receiving faxes in TEL, TEL/FAX and FAX modes, see Chapter 4, *Receiving Documents*. For more information on using A.M. mode, see Chapter 2, *Using the Answering Machine*.

Volume Adjustment

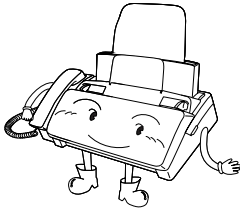

You can adjust the volume of the speaker and ringer using the **UP** and **DOWN** keys.

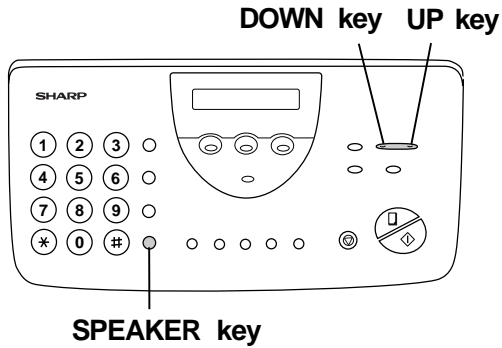

Speaker

-
- 1** Press the **SPEAKER** key.



-
- 2** Press the **UP** or **DOWN** key.

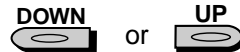

-
- 3** When the display shows the desired volume level, press the **SPEAKER** key to turn off the speaker.



Ringer

- 1 Press the **UP** or **DOWN** key. (Make sure the **SPEAKER** key has not been pressed and the handset is not lifted.)

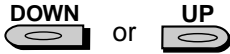

- The ringer will ring once at the selected level, then the date and time will reappear in the display.

Display:

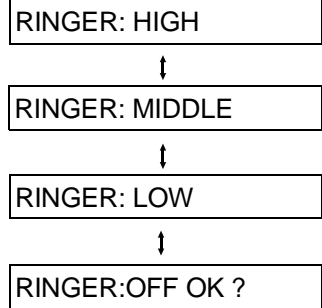

- 2 If you selected RINGER:OFF OK ?, press the **START/MEMORY** key.



Note: When set to TEL mode, the fax machine will ring even if the ringer is turned off. When set to TEL/FAX mode, the special "pseudo ringing" sound will be generated if the machine detects a voice call or manually dialled fax.

Using the Answering Machine

The UX-470's built-in answering machine allows you to receive both voice messages and fax transmissions while you are out.

To use the answering machine, record an outgoing message and then set the reception mode to A.M. when you go out.

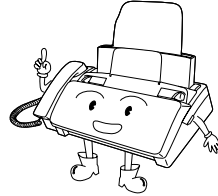

Recording an Outgoing Message

The outgoing message (OGM) is the greeting that the machine plays after answering a call to inform callers that they can leave a message or send a fax.

- ◆ The general message box must warn callers that no further recording is possible if one long beep followed by four consecutive short beeps are heard.

Example:

"Hello. You've reached the ABC company. No one is available to take your call right now. Please leave a message after the beep or press your facsimile Start key to send a fax. If while recording a message you should hear one long beep followed by four consecutive short beeps, no more recording is possible. Thank you for calling."

- 1** Press these keys:

FUNCTION



The display will show: A.M. SETTINGS

- 2** Press the # key.



The display will show: OGM RECORDING

- 3** Press the **START/MEMORY** key.



- 4** Press **1** to select **GENERAL**. (If you are recording a message for the Transfer function explained later in this chapter, press **2** for **TRANSFER**.)

GENERAL TRANSFER

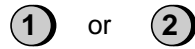

- 5** Press the **REC/MEMO** key, and then speak facing the "**MIC**" mark on the lower left corner of the machine at a distance of about 30 cm.



- The outgoing message can be up to 60 seconds long. The outgoing message for the Transfer function can be up to 15 seconds long.
- While recording, the display will show the time remaining to record.

- 6** When finished, press the **STOP** key.

- If your message exceeds the time limit or more than 6 seconds of silence is detected, recording will stop automatically.



- 7** Press the **STOP** key twice to return to the date and time display.



To listen to the outgoing message

To listen to the outgoing message, follow Steps 1 through 4 of the above procedure to select the message, and then press the **PLAY/SKIP** key to listen to it. To return to the date and time display, press the **STOP** key twice. Note that the general outgoing message cannot be erased. If you need to change it, simply repeat the recording procedure. (The Transfer message can be deleted by pressing the **DELETE** key after selecting it as explained above.)

Operating the Answering Machine

Activating the answering machine

Activate the answering machine before you go out as follows:

Press the **RECEPTION MODE** key until the arrow in the display points to **A.M.**

- The outgoing message will play (you can stop playback by pressing the **STOP** key).
- It will not be possible to set the reception mode to A.M. if a general outgoing message has not been recorded.

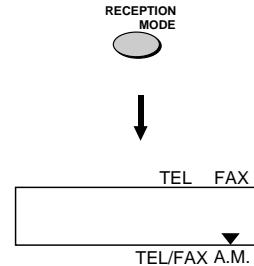

When the reception mode is set to A.M., the UX-470 will answer incoming calls after two rings if it has received at least one incoming message, or after four rings if no messages have been received. (For more information, see *Toll Saver in Remote Operations* in this chapter.)

Note: If the memory is full from messages previously recorded, **MEMORY IS FULL** will appear in the display. To set the reception mode to A.M., you must first erase some or all of the stored messages.

Note: In A.M. mode, the machine will automatically switch to fax reception if it detects a period of silence longer than six seconds after answering a call. For this reason, if a caller pauses for this length of time while leaving a message, they will be cut off.

Listening to received messages

When you return, the display will show the number of messages recorded. Listen to the messages as follows:

1 Press the **PLAY/SKIP** key.

- If you only want to listen to new messages (messages not previously listened to), continue to hold the **PLAY/SKIP** key down for at least two seconds.



2 The messages will play.

- As each message plays, the date and time of recording will appear briefly in the display. If no messages were received, NO MESSAGES will appear.
- To listen to a message a second time, press the **REPEAT** key before playback of that message ends.
- To move back to the previous message, press the **REPEAT** key within 3 seconds of the beginning of the current message.
- To skip forward to the next message, press the **PLAY/SKIP** key.



Note: Playback will stop if you receive a call, lift the handset, or press the **STOP** key.

Erasing received messages

It is important to erase received messages after you listen to them to ensure that the memory does not become full.

- **Erasing all messages:** To erase all messages, press and hold down the **DELETE** key for at least 2 seconds.
- **Erasing a single message:** To erase only a single message, press the **DELETE** key while the message is being played.



Recording Memos and Telephone Conversations

You can use the **REC/MEMO** key to record telephone conversations and messages for other users of the UX-470. These will be played back together with any incoming messages when the **PLAY/SKIP** key is pressed.

- **Recording messages:** To record a message, hold down the **REC/MEMO** key and speak facing the "MIC" mark on the lower left corner of the machine at a distance of about 20 to 30 cm. When you have finished speaking, release the **STOP** key.
- **Recording phone conversations:** To record a phone conversation, hold down the **REC/MEMO** key during the conversation you want to record (while recording, you will hear a beep every 15 seconds). When you are finished, release the key.



Date and time of ICMs

You can check the date and time of your received messages by pressing the panel keys as shown below.

- ◆ The dates and times are also shown in the Message List, which can be printed out as described in Chapter 9.

1 Press these keys:



The display will show: A.M. SETTINGS

2 Press these keys:



The display will show: ICM CONFIRMATION

3 Press the **START/MEMORY** key.
The number of messages recorded will appear in the display.



4 Press # or * one or more times to show the date and time of each of the messages.

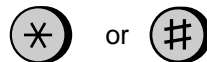

- The message number will appear first, and then the date and time several seconds later.

5 Press the **STOP** key.



Note: The recorded dates and times are cleared each time you erase the messages.

Optional Answering Machine Settings

Setting ICM time

Incoming messages (ICMs) are the messages which callers leave for you on the built-in answering machine. The answering machine is set at the factory to allow each caller a maximum of 4 minutes to leave a message. If desired, you can change this setting to 15, 30, or 60 seconds.

1 Press these keys:

FUNCTION



The display will show: A.M. SETTINGS

2 Press these keys:



The display will show: ICM RECORD TIME

3 Press a numeric key to select the desired ICM recording time:

- **1:** 15 seconds 1
- **2:** 30 seconds 2
- **3:** 60 seconds 3
- **4:** 4 minutes 4

4 Press the **STOP** key.

STOP



Fax reception on A.M. failure

If the memory for recording incoming messages becomes full while you are out, the answering machine will no longer be able to record messages. The ON A.M. FAILURE setting is used to choose the response of the machine to incoming calls when this happens:

- ◆ Automatic fax reception NO: The UX-470 will answer after 20 rings, after which it will wait to receive a remote command. Most callers will hang up before it answers; however, when you call the UX-470 from a remote location, you can wait until it answers, listen to your messages, and then erase them (see *Remote Operations* in this chapter).
- ◆ Automatic fax reception YES: The reception mode will switch to **FAX** mode, allowing the UX-470 to continue to receive faxes automatically without broadcasting an OGM on answering. With this setting, you can still use the remote commands to listen to your messages and erase the message memory (see *Remote Operations* in this chapter).

Automatic fax reception is set to NO at the factory before shipping. If you want to set it to YES, press the panel keys as follows:

1 Press these keys:



The display will show: A.M. SETTINGS

2 Press these keys:



The display will show: ON A.M. FAILURE

3 Press **1** to turn automatic fax reception on, or **2** to turn it off.

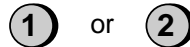

4 Press the **STOP** key.



Calling Party Control detection

When a caller hangs up, your local telephone exchange will issue a signal called a Calling Party Control (CPC) signal via the telephone line. Your UX-470 has been set to detect this signal, and this allows it to immediately stop recording when a caller hangs up, thereby saving memory space and freeing you from having to listen to long periods of inter-message silence when you play back your messages.

However, if you are a subscriber to such telephone services as Call Waiting or Call Forwarding, signals used by these services may be mistaken for a CPC signal, causing the machine to hang up during a call. In this case, follow the steps below to turn off CPC detection.

Note: CPC may not operate from some types of telephone exchanges. For this reason, periods of silence and/or telephone exchange end of call signals may be recorded even if CPC detection is turned on.

1 Press these keys:

FUNCTION



The display will show:

A.M. SETTINGS

2 Press these keys:



The display will show:

CPC DETECTION

3 Press "1" to turn CPC detection on, or "2" to turn it off.



or



4 Press the **STOP** key.

STOP



OGM only mode

If needed, you can turn off recording of incoming messages. In this case, your outgoing message will play, but callers will not be able to leave a message. (The machine will still receive faxes sent by automatic dialling.)

1 Press these keys:

FUNCTION



The display will show:

OGM ONLY MODE

2 Press **1** to turn on OGM only mode, or
2 to turn it off.



or



3 Press the **STOP** key.

STOP



Transfer Function

The Transfer function is used to make the UX-470 automatically call you at a specified number every time it receives an incoming message. This lets you hear your messages immediately after they come in, even when you are at a remote location.

When you answer the telephone, you will hear your recorded message telling you that the call is a transfer call. Enter "#", your remote code number, and "#". The answering machine will then play back your messages. You can also perform any of the remote operations described in the previous section.

Note: When you hang up after a transfer call, the UX-470 will not immediately resume normal operation. If you want the UX-470 to accept calls immediately after a transfer call, enter "*" twice before hanging up (if you want to hang up during message playback, first enter "0" and "#" to stop playback, then enter "*" twice).

Programming the transfer number

To use the Transfer function, you must first give the UX-470 the number to call (the transfer number). This is done by pressing the panel keys as follows:

1 Press these keys:

FUNCTION



The display will show:

A.M. SETTINGS

2 Press these keys:



The display will show:

TRANSFER # ENTRY

- 3** Press the **START/MEMORY** key.



- 4** Enter a transfer number (max. of 32 digits including pauses) by pressing the number keys.



(Example)

- 5** Press the **START/MEMORY** key and then the **STOP** key.



Recording the transfer message

The transfer message plays when you answer the telephone, and informs you that the call is a transfer call. It can be up to 15 seconds long. To record a transfer message, follow the steps described in *Recording an Outgoing Message* in this chapter. The following is an example:

"Hello. This is a transfer call for (YOUR NAME). Enter your remote code number now."

Turning the Transfer function on and off**1** Press these keys:

FUNCTION

The display will show: **2** Press these keys:The display will show: **3** Press **1** to turn the Transfer function on, or **2** to turn it off.

or

**4** Press the **STOP** key.

STOP



Override Ringing

This function allows selected callers using a tone dial telephone to override the answering machine's outgoing message and cause the UX-470 to make a special ringing sound, alerting you that they are calling. This is useful when you are near the machine but only want to talk with certain callers, taking all other calls on the answering machine.

Programming the override code

To override the answering machine, your callers must enter a 3-digit override code from their telephone. This code has been set to "009" at the factory. If you want to change it, press the panel keys as shown below.

Important!

- Make sure the override code is different from the remote code used for remote operations.

1 Press these keys:

FUNCTION



The display will show:

2 Press these keys:



The display will show:

3 Enter a 3-digit code number by pressing the number keys.



(Example)

4 Press the **START/MEMORY** key and then the **STOP** key.



Overriding the answering machine

Your callers should follow the steps below to override the answering machine.

- 1** Your caller calls the UX-470 from a tone dial telephone. When the outgoing message begins, they should press the "#" key on their telephone.



- The caller will hear a short beep, and the outgoing message will stop.

- 2** The caller should enter the override code and "#" by pressing the appropriate keys on their telephone.



(Example)

- If an incorrect code is entered, the caller will hear four beeps. He or she must re-enter the correct code within 10 seconds or the line will be disconnected.

- 3** The UX-470 will make a special ringing sound. Pick up the handset to answer the call. (Note that an extension telephone connected to the same line will not ring.)

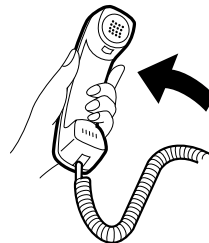

- If you do not answer within 30 seconds, the outgoing message will play again and the caller can then leave a message.

Remote Operations

You can call the UX-470 from any tone dial telephone and play back your messages using the remote commands. You can also use these commands to change the reception mode and other settings.

Remote code number

To perform remote operations, you must first program a remote code number. This number is used to prevent unauthorised people from listening to your messages or changing the settings of your machine.

The remote code number has been set to "001" at the factory. If you want to change it, press the panel keys as shown below.

1 Press these keys:



The display will show: A.M. SETTINGS

2 Press these keys:



The display will show: REMOTE CODE

3 Enter a 3-digit number by pressing the number keys.



(Example)

4 Press the **START/MEMORY** key and then the **STOP** key.



Toll Saver

When you call the UX-470 to listen to your messages, it will answer after two rings if it has received at least one message, or after four rings if it has not received any messages.

This allows you to save money on telephone charges, particularly if you are calling long distance. If the machine does not answer after the second ring, you can simply hang up before it answers, saving yourself the cost of that call.

If you do not want to use the Toll Saver function, you can turn it off by following the steps below. In this case, the UX-470 will answer after the number of rings set with Option Setting 3 (see Chapter 8), the ring setting for FAX reception mode.

- 1** Press these keys:



The display will show: A.M. SETTINGS

- 2** Press these keys:



The display will show: TOLL SAVER

- 3** Press **1** to turn Toll Saver on, or **2** to turn it off.



or



- 4** Press the **STOP** key.



Retrieving your messages

Note: You can also access the UX-470 for remote operation when the reception mode is set to FAX. In this case, call the UX-470, press the "#" key immediately after it answers, and then continue from Step 2 below.

1 Call the UX-470 from a touch-tone telephone. When your outgoing message begins, press the "#" key on the telephone.



- You will hear a short beep, and the outgoing message will stop.

2 Enter your remote code number and then # by pressing the keys on the telephone.



(Example)

- You will hear a series of beeps equal to the number of messages recorded, or one long beep if four or more messages have been received. The machine will then play back the messages, beeping once at the end of each message. When all messages have been played back, you will hear a long beep.
- If no messages have been received, you will hear a short beep. You can either hang up, or perform any of the operations described in the following section *Other remote operations*.

3 While the messages are playing, you can do any of the following:

- **Repeat:** To listen to a message a second time, press "2" and "#" on the telephone before that message ends. To move back to the previous message, press "2" and "#" within the first 3 seconds of the current message.



- **Skip forward:** To skip forward to the next message, press "5" and "#" on the telephone.



- **Stop:** To stop playback, press "0" and "#" on the telephone. After this, you can enter any of the commands described in the following section, "Other remote operations".



- **Play new messages:** To listen to only your new messages, first stop playback by pressing "0" and "#", and then press "6" and "#".



- **Erase a message:** To erase the message you are currently listening to, press "3" and "#" before it ends.



5 When you have finished listening to your messages, you can do any of the following:

- **Erase all messages:** To erase all of your messages, press "3", "3", and "#".



- **Repeat playback:** To listen to your messages again, press "7" and "#".
- **Perform other operations:** You can enter any of the commands described in the following section, *Other remote operations*.
- **Hang up:** If you do not erase your messages first, they will be saved and any new messages will be recorded after them. If you want the UX-470 to resume normal operation immediately, press "*" twice before hanging up (in some cases, particularly when the Transfer function is used, the UX-470 may not accept new calls for one or two minutes after you hang up unless you first press "*" twice).



Comments:

- When a remote command is accepted by the machine, you will hear one beep. If an incorrect command is entered, you will hear four beeps. In the latter case, re-enter the correct command.
- When entering a command, do not pause longer than 10 seconds between each digit. If you do, a 4-beep error signal will be issued and the digits entered up to that point will be disregarded. In this case, re-enter the command from the beginning.
- If you make two errors (causing two 4-beep signals to be issued) while entering your remote code number, the line will be disconnected. This prevents unauthorized people from attempting to guess your remote code number.
- If you pause for longer than 10 seconds before entering a command, you will be disconnected.

Other remote operations

After listening to your messages, you can do any of the operations described below by pressing the appropriate keys on the telephone.

Note: The following commands cannot be entered while messages are being played back. If you do not want to wait until playback ends to enter a command, first stop playback by pressing "0" and "#", and then enter the command.

Changing the fax reception mode

Select a new reception mode by pressing the keys as follows:

- **A.M.** mode: "8", "1", and "#".
- **FAX** mode: "8", "2", and "#".
- **TEL** mode: "8", "3", and "#".



(Example)

Caution: In TEL mode, you will not be able to further change the reception mode.

- **TEL/FAX** mode: "8", "4", and "#".

Recording a new outgoing message

- 1 Press "4" and "* " on the telephone.



2 When you hear a short beep, speak into the telephone to record the new message.

- The message can be up to 15 seconds long. After 15 seconds (or earlier if the machine detects silence after you finish speaking), you will hear a beep, and the new message will be played back.

Turning the Transfer function on or off

To turn Transfer on: Press "9", "1", and "#" on the telephone.



To turn Transfer off: Press "9", "2", and "#" on the telephone.

(Example)

Changing the transfer telephone number

1 Press "9", "0", and "#" on the telephone.



2 After you hear a short beep, enter the new telephone number. When finished, press "#".



- To insert a pause between any two digits of the number, press "*".

(Example)

Recording a new transfer message

-
- 1** Press "9", "3", and "#" on the telephone.



-
- 2** When you hear a short beep, speak into the telephone to record the new message.

- The time for the transfer message is fixed at 15 seconds. After 15 seconds (or earlier if the machine detects silence after you finish speaking), you will hear a beep, and the new message will be played back automatically.

Recording a "Memo"

You can record a "memo" for yourself or other users of the UX-470. The memo will be played back when incoming messages are listened to.

-
- 1** Press "*" and "#" on the telephone.



-
- 2** When you hear a short beep, speak into the telephone to record the memo.

-
- 3** When you are finished, press "0" and "#".



- If the UX-470 detects a certain period of silence, it will stop recording automatically.

OGM only mode

To turn on OGM only mode, press "1", "1", and "#". (Your outgoing message will play, but callers will not be able to record a message. Faxes sent by automatic dialling will be received).



To turn off OGM only mode, press "1", "2", and "#".



Sending Documents

Transmittable Documents

Size and weight

The size and weight of documents that you can load in the document feeder depend on whether you load one page at a time or several pages at once.

Loading one page at a time:

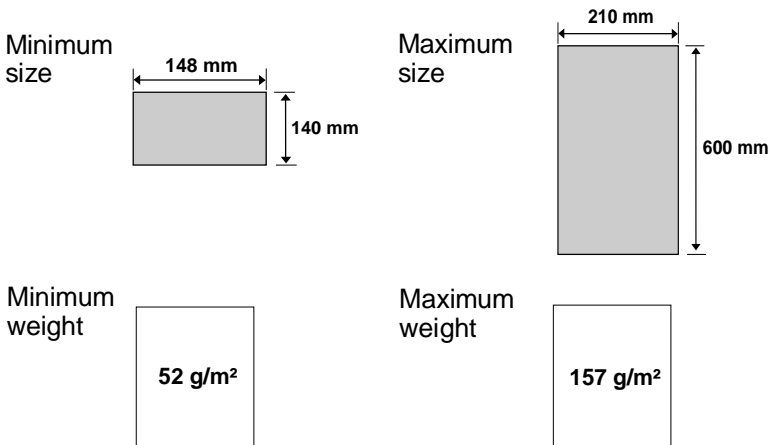

Loading several pages at once:

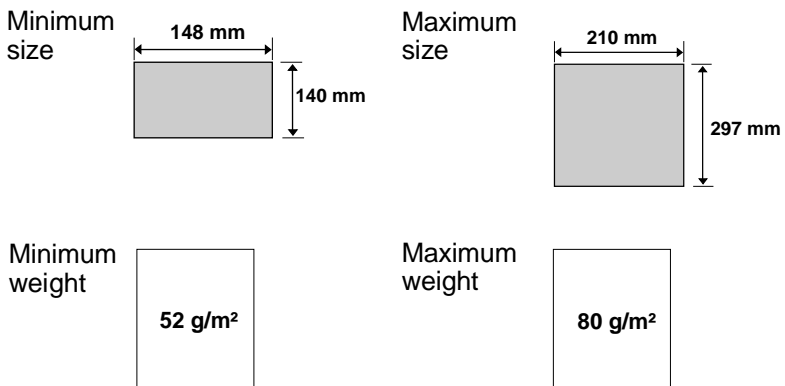

Note: Letters or graphics on the edges of a document will not be scanned.

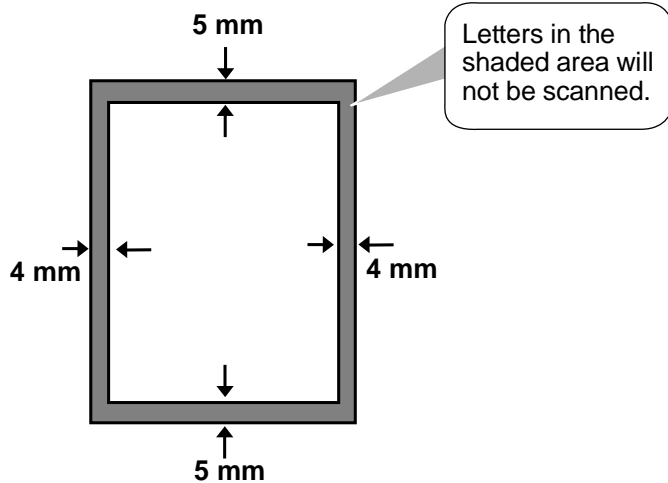

Other restrictions

- ◆ The scanner cannot recognise yellow, greenish yellow, or light blue ink.
- ◆ Ink, glue, and correcting fluid on documents must be dry before they pass through the document feeder.
- ◆ All clips, staples, and pins must be removed from documents before loading in the feeder. If these are not removed, they may damage the machine.
- ◆ Documents which are patched, taped, torn, smaller than the minimum size, carbon backed, easily smudged, or have a slippery coated surface should be photocopied, and the copy loaded in the feeder.

Loading the Document

Up to 10 pages can be placed in the feeder at one time. The pages will automatically feed into the machine starting from the bottom page.

- ◆ If you need to send or copy more than 10 pages, place the additional pages gently and carefully in the feeder just before the last page is scanned. Do not try to force them in, as this may cause double-feeding or jamming.
- ◆ If your document consists of several large or thick pages which must be loaded one at a time, insert each page into the feeder as the previous page is being scanned. Insert gently to prevent double-feeding.

-
- 1** Adjust the document guides to the width of your document.



-
- 2** Place the document face down and push it gently into the document feeder. The top edge of the document should enter the machine first.

- The feeder will draw the leading edge of the document into the machine. The display will show:

READY TO SEND

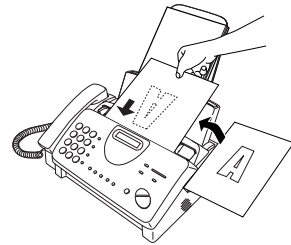

-
- 3** Adjust the resolution and/or contrast setting (if desired) as explained in the section *Resolution and Contrast*, then dial the receiving machine as explained in *Sending a Fax by Normal Dialling*.



Removing a document from the feeder

If you need to remove a document from the feeder, open the operation panel.

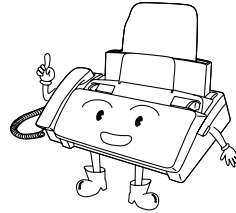

Important:

Do not try to remove a document without opening the operation panel. This may damage the feeder mechanism.

- 1 Open the operation panel by grasping the finger hold and pulling up.

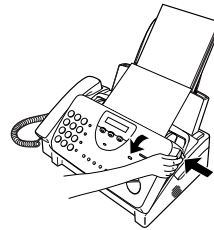

- 2 Remove the document.

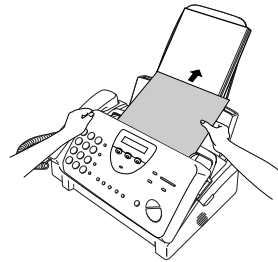

- 3 Close the operation panel, making sure it clicks into place.

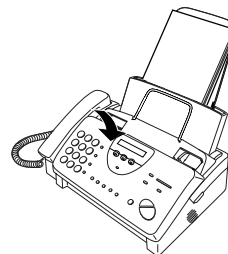

Click!

Resolution and Contrast

If desired, you can adjust the resolution and contrast before sending a document.

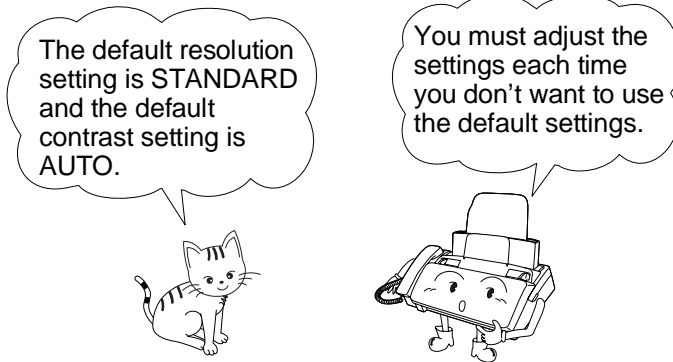

Note: The resolution and contrast settings are only effective for transmitting and copying a document. They are not effective for receiving a document.

Resolution settings

- STANDARD:** Use STANDARD for ordinary documents. This setting gives you the fastest and most economical transmission.
- FINE:** Use FINE for documents containing small letters or fine drawings.
- SUPER FINE:** Use SUPER FINE for documents containing very small letters or very fine drawings.
- HALF TONE:** Use HALF TONE for photographs and illustrations. The original will be reproduced in 64 shades of grey.

Contrast settings

- AUTO** Use AUTO for normal documents.
- DARK** Use DARK for faint documents.

1 Load the document(s).

- The document must be loaded before the resolution and contrast can be adjusted.

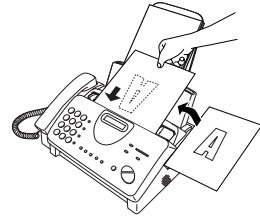

2 Press the **RESOLUTION** key one or more times until the desired resolution and contrast settings appear in the display.

- The first time you move through the list of resolution settings, the contrast setting AUTO will appear next to each resolution setting. The second time you move through the list, the contrast setting DARK will appear.



Display:

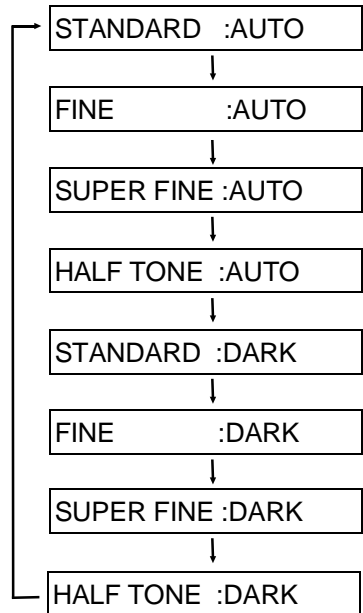

Note: In order to transmit in FINE or SUPER FINE resolution, the receiving fax machine must also have that resolution. If it doesn't, your machine will automatically step down to the next best available setting.

Sending a Fax by Normal Dialling

With Normal Dialling, you pick up the handset (or press the **SPEAKER** key) and dial by pressing the number keys.

- ◆ If a person answers, you can talk with them through the handset before sending the fax. (If you pressed the **SPEAKER** key, you must pick up the handset to talk.)
- ◆ Normal Dialling allows you to listen to the line and make sure the other fax machine is responding.

1 Load the document(s).

The display will show:

READY TO SEND

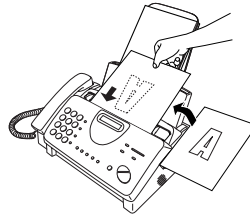

- Set the resolution and/or contrast if desired.



2 Pick up the handset or press the **SPEAKER** key. Listen for the dial tone.

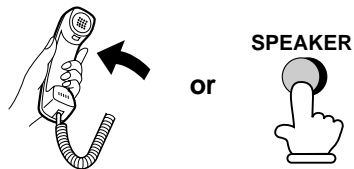

3 Dial the number of the receiving machine by pressing the numeric keys.

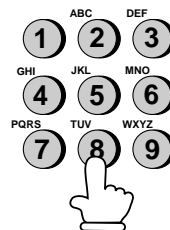

4 Wait for the connection. Depending on the setting of the receiving machine, you will either hear a facsimile reception tone or the other person will answer.

- If the other party answers, (lift the handset if the **SPEAKER** key was pressed) ask them to press their **START/MEMORY** key. This causes the receiving machine to issue a reception tone.

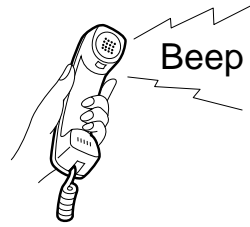

5 When you hear the reception tone, press the **START/MEMORY** key. Replace the handset if you used it.

- When transmission is completed, the fax will beep once.

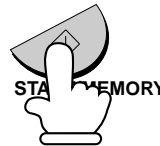

Using the REDIAL key

You can press the **REDIAL** key to redial the last number dialled. To send a document, proceed from Step 4 of Normal Dialling. Note that the speaker will be automatically activated when you press the **REDIAL** key.

Facsimile reception tone: This is a pronounced, high-pitched tone that the receiving machine sends to the transmitting machine to indicate that it is ready to receive.

Sending a Fax by Automatic Dialling

You can dial a fax or telephone number by simply pressing a Rapid Key, or by pressing the **SPEED DIAL** key and entering a two-digit number.

- ◆ To use Automatic Dialling, you must first store the full fax or telephone number in your fax machine.
- ◆ When you store a fax or telephone number, you select a two-digit Speed Dial number for it. 45 Speed Dial numbers are available.

Speed Dial numbers 01 through 05 are for Rapid Key (one-touch) Dialling.



Speed Dial numbers 06 through 45 are for dialling with the **SPEED DIAL** key.

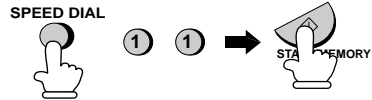

SPEED DIAL key

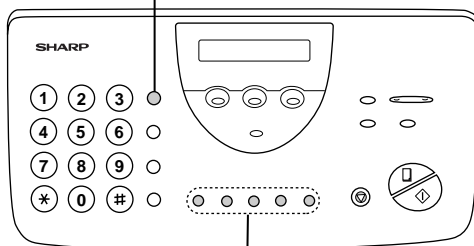

Attach the strip of Rapid Key labels above the Rapid Keys.

Rapid keys

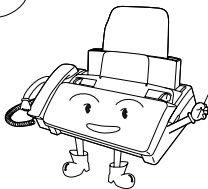

When you store a number in a Rapid Key, write the name of the party on the label.

Storing fax and telephone numbers for Automatic Dialling

1 Press these keys:

FUNCTION



3



The display will show: FAX/TEL # MODE

2 Press 1 to select SET.

1

The display will show: FAX/TEL # SET



ENTER SPEED #

3 Enter a two-digit Speed Dial number by pressing the number keys (01 to 05 for Rapid Key Dialling, 06 to 45 for Speed Dialling).

0

1

(Example)

4 Enter the fax or voice number by pressing the number keys (max. of 32 digits including pauses).

- Press the **SPEED DIAL** key to clear a mistake.
- If a pause is required between any of the digits to access a special service or an outside line, press the **REDIAL** key. The pause will appear as a hyphen. Several pauses can be entered in a row.
- Press the **SEARCH/R** key to enter a space between digits.



















































































5 Press the **START/MEMORY** key.



6 Enter the name of the party by pressing the number keys as shown in the chart below. Up to 20 characters can be entered.

- If you don't want to enter a name, skip this step.
- To enter two letters in succession that require the same key, press the **SPEAKER** key after entering the first letter to advance the cursor.

Example: SHARP = 7 7 7 7 7 4 4 4 2 2 7 7 7 7  7 7

A =  	J =  	S =     
B =   	K =   	T =  
C =    	L =    	U =   
D =  	M =  	V =    
E =   	N =   	W =  
F =    	O =    	X =   
G =  	P =  	Y =    
H =   	Q =   	Z =    
I =    	R =    	SPACE =  

7 Press the **START/MEMORY** key.



8 Return to Step 3 to store another number, or press **STOP** to exit. If the number will be used for Rapid Key Dialling, you can write the name on the appropriate Rapid Key label.

Step 3 or 

Note: Numbers stored for automatic dialling will appear on the "Telephone Number List" printout, so this facility should not be used to store least cost routing or system access passwords which need to remain private.

Note: To confirm that Automatic Dialling numbers have been stored correctly, print out the Telephone List. The procedure for doing this is explained in Chapter 9, *Printing out Reports and Lists*.

Storing area codes and access codes

You can also store an area code or access code in a Rapid Key or Speed Dial number. To use this number to dial, see *Chain Dialling* in Chapter 6, *Making Telephone Calls*.

Note: An area code or access code stored in a Rapid Key or Speed Dial number can only be used if the handset is lifted or the **SPEAKER** key pressed before dialling.

Clearing numbers

1 Press these keys:



The display will show: FAX/TEL # MODE

2 Press **2** to select CLEAR.



3 Enter the Speed Dial number that you want to clear by pressing the number keys.



4 Press the **START/MEMORY** key.



5 Return to Step 3 to clear another number, or press **STOP** to exit.

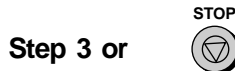

Making changes

To make changes in a number previously stored, repeat the storing procedure. Select the Speed Dial number for which you want to make changes in Step 3, and then change the number and/or name when they appear in the display (Steps 4 and 6, respectively).

◆ A lithium battery keeps automatic dialling numbers in memory

The machine uses a lithium battery to keep automatic dialling numbers and other programmed data in memory when the power is turned off. Battery power is consumed primarily when the power is off. With the power kept continuously off, the life of the battery is about 5 years. If the battery dies, have your dealer or retailer replace it. Do not try to replace it yourself.

Rapid Key Dialling

If the number you want to dial has been stored for Automatic Dialling as a Speed Dial number from 01 to 05, you can dial it by pressing the corresponding Rapid Key.

1 Load the document(s).

The display will show:

READY TO SEND

- Set the resolution and/or contrast if desired.

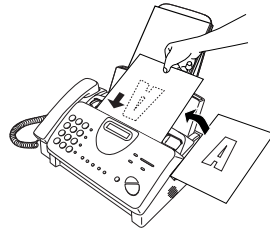

RESOLUTION



2 Press the Rapid Key corresponding to the desired Speed Dial number.

- The name of the receiving party will appear in the display. If no name was stored, the fax number will appear. (If the name or number is incorrect, press the **STOP** key.)
- The document will be automatically transmitted once the connection is made.

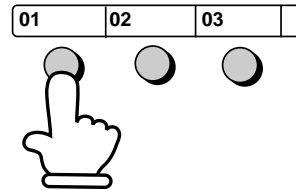

Example: To dial Speed Dial number 01, press Rapid Key 01.

Speed Dialling

Speed Dialling can be used to dial any number that has been stored for Automatic Dialling.

1 Load the document(s).

The display will show:

READY TO SEND

- Set the resolution and/or contrast if desired.

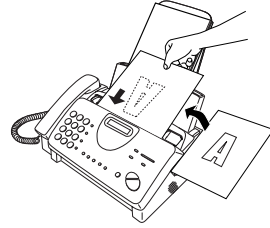

2 Press the **SPEED DIAL** key and then enter the two digits of the Speed Dial number by pressing the number keys.

- To enter numbers 1 through 9, first enter 0 and then the number.

SPEED DIAL



(Example)

3 Check the display. If the name or number shown is correct, press the **START/MEMORY** key. (If not, press the **STOP** key and then repeat Step 2.)

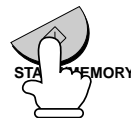

Direct Keypad Dialling

You can also enter a full number with the number keys and then press the **START/MEMORY** key to begin dialling. You can use this method to dial a full number when you don't need to speak to the other party before faxing.

1 Load the document(s).

The display will show:

READY TO SEND

- Set the resolution and/or contrast if desired.

RESOLUTION

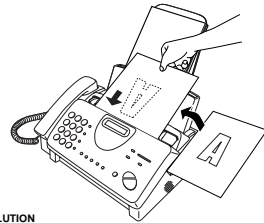

2 Enter the number of the receiving machine by pressing the numeric keys.

- If a pause is required between any of the digits to access a special service or an outside line, press the **REDIAL** key. The pause will appear as a hyphen. Several pauses can be entered in a row.

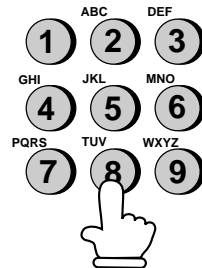

3 Check the display. If the number of the receiving machine shown is correct, press the **START/MEMORY** key.

- If it is not correct, press the **STOP** key to backspace and clear one digit at a time, and then re-enter the correct digit(s).

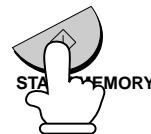

Using the **SEARCH/R** key

If you can't remember the Rapid Key or Speed Dial number in which you have stored a particular fax number, you can search for the number by following the steps below. Once you have found the number, you can dial it and transmit the loaded document by simply pressing the **START/MEMORY** key.

1 Load the document(s).

The display will show:

READY TO SEND

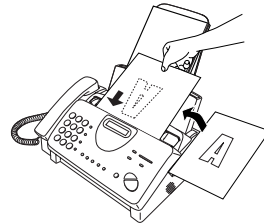

- Set the resolution and/or contrast if desired.



2 Press the **SEARCH/R** key and then the **1** key.



3 Enter the first letter of the stored name by pressing the appropriate number key (the key which corresponds to the required letter) one or more times until the letter appears in the display. If the name begins with a special character or number, press **1**.

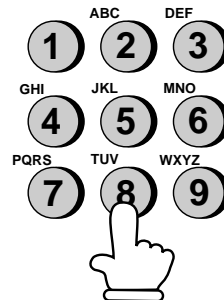

- If you can't remember the first letter, go to Step 4 (you will scroll through the list from the beginning).
- If a name wasn't stored for the number, press **0**. This will cause numbers, not names, to appear when you scroll.

- 4** Press the # key or the * key to scroll through the names (numbers if you pressed 0). Stop when the desired name appears in the display.

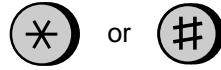

- If no names have been stored that begin with the entered letter, you will scroll from the next name, in alphabetical order, in the list. If no names/numbers have been stored at all, NO DATA will appear.

- 5** Press the **START/MEMORY** key. The document will be automatically transmitted once the connection is made.

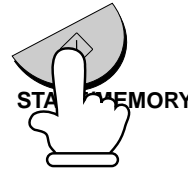

Automatic redialling

If you use automatic dialling (including Direct Keypad Dialling) and the line is busy, the machine will automatically redial the number. Up to 2 redialling attempts will be made at intervals of 5 minutes.

- ◆ To stop automatic redialling, press the **STOP** key.
- ◆ If desired, you can change the number of times the machine redials with Option Setting 5, and the interval at which redialling takes place with Option Setting 4. See Chapter 8, *Option Settings*.

Receiving Documents

Using TEL/FAX Mode

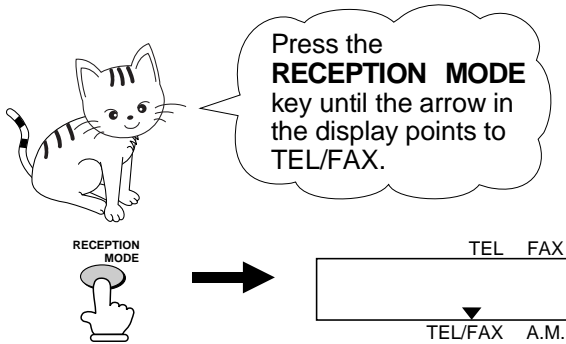

When the reception mode is set to TEL/FAX, your fax automatically answers all calls on 1 ring. After answering, your fax monitors the line for about 5 seconds to see if a fax tone is being sent.

- ◆ If your fax detects a fax tone (this means that the call is an automatically dialled fax), it will automatically begin reception of the incoming document.
- ◆ If your fax doesn't detect a fax tone (this means that the call is a voice call or manually dialled fax), it will make a ringing sound (called pseudo ringing) for 15 seconds to alert you to answer. If you don't answer within this time, your fax will send a fax tone to the other machine to allow the calling party to send a fax manually if they desire.

Comments:

- Only the fax will alert you to voice calls or manually dialled faxes by pseudo ringing. An extension phone connected to the same line will not ring after the connection has been made. The handset of a parallel extension telephone can, however, be picked up to answer the call. To stop pseudo ringing once the handset is lifted, press "#" key on the dial pad of the phone (this is only possible from a tone dial phone). If pseudo ringing is not cancelled in this way, the fax machine will send fax tones down the line, rendering conversation impossible.
- The duration of pseudo ringing can be adjusted with Option Setting 10. See Chapter 8, *Option Settings*.

- You can change the number of rings on which the machine answers calls by changing Option Setting 3. (See Chapter 8, *Option Settings*.)

Using FAX Mode

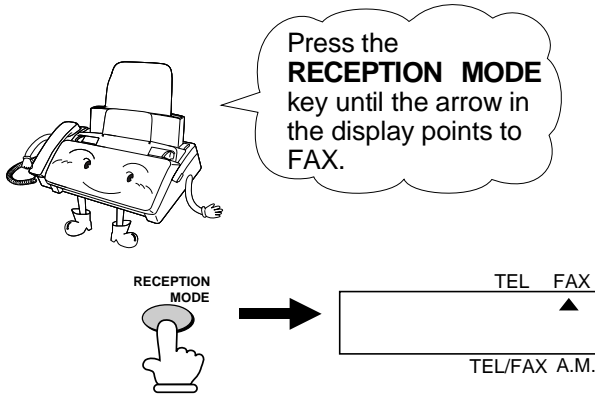

When the reception mode is set to FAX, the machine will automatically answer all calls on 1 ring and receive incoming faxes.

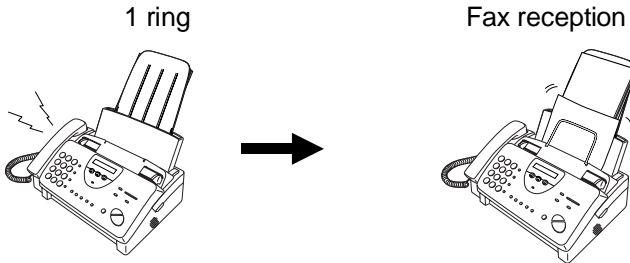

- ◆ You can change the number of rings on which the machine answers calls by changing Option Setting 3. (See Chapter 8, *Option Settings*.)
- ◆ If you pick up the handset before the machine answers, you can talk to the other party and/or receive a document as described in *Using TEL mode*.

Using A.M. Mode



Press the **RECEPTION MODE** key until the arrow in the display points to A.M.

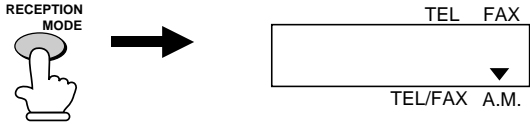

In A.M. mode, your fax machine will automatically receive voice messages and faxes. See Chapter 2 for more details.

Using TEL Mode

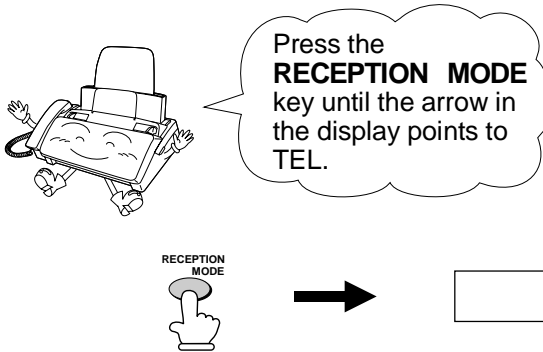

When the reception mode is set to TEL, you must answer all calls using the fax machine's handset or an extension phone connected to the same line.

Answering with the fax's handset

- 1 Pick up the handset when the machine rings.

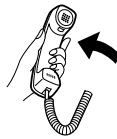

- 2 If you hear a fax tone, wait until the display shows RECEIVING and then replace the handset.

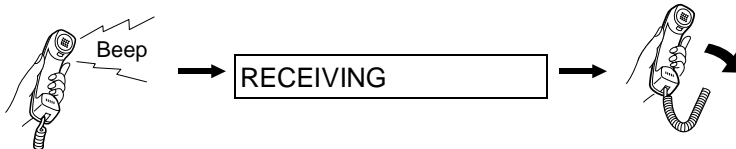

Note: If you have set Option Setting 12 (Fax signal receive) to NO, press the **START/MEMORY** key to begin reception.

-
- 3** If the other party first talks and then wants to send a fax, press the **START/MEMORY** key after speaking (press your **START/MEMORY** key before the sender presses their Start key).
- Make sure that the display shows **RECEIVING**, then replace the handset.



Answering with an extension phone

- 1** Answer the extension phone when it rings.

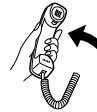

-
- 2** If you hear a soft fax tone, wait until your fax responds (the extension phone will go dead if it is connected to your fax, or you will hear pronounced, high-pitched tones if the phone is connected to a separate wall socket), then hang up.

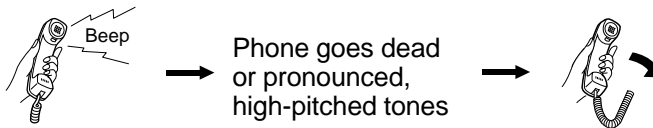

-
- 3** If the fax doesn't respond, or if the other party first talks to you and then wants to send a fax, press **5**, *****, and ***** on the extension phone (only on a tone dial phone). This signals the fax to begin reception. Hang up.

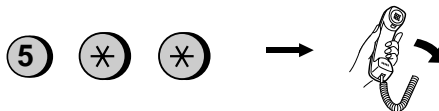

Comments:

- Your fax will not accept the signal to begin reception (**5****) if a document is loaded in its feeder.
- If you have set Option Setting 12 to NO and hear a fax tone when you answer the extension phone, you must press **5**, *****, and ***** if you are on a tone dial phone, or walk over to the fax, pick up the handset, and press the **START/MEMORY** key if you are on a pulse dial only phone.
- The code used to activate fax reception from a tone dial extension phone (**5****) can be changed if desired. See Option Setting 6 (Tel/Fax Remote Number) in Chapter 8, *Option Settings*.

2 in 1 Print

To save paper, you can have the size of your incoming faxes reduced by 55%. This will allow you to receive, for example, a 2-page document on one page (note that this may not be possible if the document pages are longer than your printing paper). To turn on this function, follow the steps below.

1 Press these keys:



The display will show: 2 IN 1 PRINT

2 Press **1** to turn on the function, or **2** to turn it off.

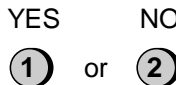

The display will show: PRINT CONTRAST

3 Press the **STOP** key.



Reception Ratio

The fax has been set at the factory to automatically reduce the size of received documents to fit the size of the printing paper. This ensures that data on the edges of the document are not cut off. If desired, you can turn this function off and have received documents printed at full size.

Note: If a document is too long to fit on the printing paper, the remainder will be printed on a second page. In this case, the cut-off point may occur in the middle of a line.

Note: Automatic reduction may not be possible if the received document is too large, contains too many fine graphics or images, or is sent at high resolution. In this case, the remainder of the document will be printed on a second page.

1 Press these keys:



The display will show: RECEPTION RATIO

2 Press **1** to turn automatic reduction on, or **2** to turn it off.

AUTO 100%
① or ②

If you selected AUTO, go to Step 3. If you selected 100%, go to Step 4.

3 If you selected AUTO, select the reception ratio to be used in the event that the memory becomes full (automatic reduction is not possible when the memory is full). Press **1** for 93% or **2** for 100%.

93% 100%
① or ②

4 Press the **STOP** key.

STOP



Substitute Reception to Memory

In situations where printing is not possible, such as when your fax runs out of paper, the imaging film needs replacement, or the paper jams, incoming faxes will be received to memory.

When you have received a document in memory, FAX RX IN MEMORY will appear in the display, alternating with OUT OF PAPER, FILM END, or PAPER JAMMED. When you add paper, replace the imaging film, or clear the jam, the stored documents will automatically print out.

- ◆ If you received documents in memory because the fax ran out of paper, be sure to add paper which is the same size as the paper previously used. If not, the document print-out size may not match the size of the printing paper.

Making Copies

Your fax can also be used to make copies. Single and multiple copies (up to 99 per original) can be made, enabling your fax to double as a convenient office copier.

- 1 Load the document(s) face down. (Maximum of 10 pages.)

The display will show:

READY TO SEND

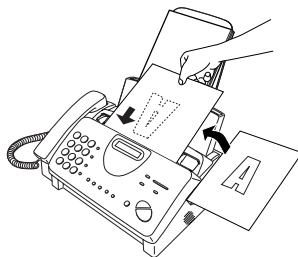

- Set the resolution and/or contrast if desired. (The default setting for copying is SUPER FINE.)

RESOLUTION



- 2 Press the **COPY/HELP** key.

The display will show:

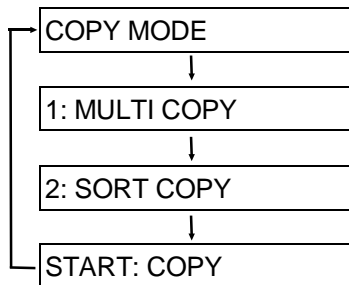

COPY/HELP

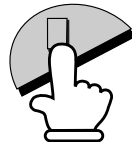

- ◆ If you are only making one copy of the original (or of each original) and don't want to make a reduction or enlargement setting, press the **START/MEMORY** key twice. Copying will begin.
- ◆ If you are only making one copy of the original (or of each original) and want to make an enlargement or reduction setting, press the **START/MEMORY** key and go to Step 5.

- 3** Press **1** (MULTI COPY) if you do not want the copies sorted. Press **2** (SORT COPY) if you want the copies sorted.

MULTI **1** or SORT **2**

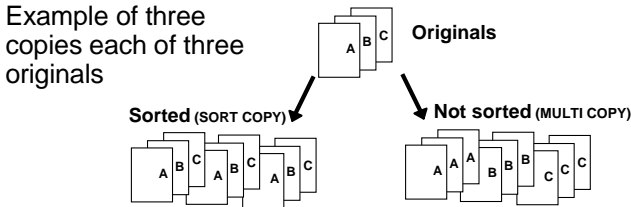

The display will show:

- 4** If you are making one copy per original, press the **START/MEMORY** key. If you are making multiple copies per original, enter the number of copies per original (if the number is less than 10, enter a "0" before the number).

0 **9**

Example: Nine copies per original

The display will show:

- 5** Set the amount of reduction or enlargement by entering a number from **1** to **5** as shown below (or press the **START/MEMORY** key to automatically select 100%). Copying will begin.

2

Example: 50%

- 1:** AUTO (automatic size adjustment to match the size of the printing paper)
- 2:** 50%
- 3:** 100% (no reduction or enlargement)
- 4:** 125%
- 5:** 135%

Note: If you place a large number of originals in the feeder, the memory may become full before all of them can be scanned (MEMORY IS FULL will appear in the display). If this happens, press the **START/MEMORY** key to copy the originals which have been scanned, and then repeat the copy procedure for the remaining originals, including the original which was being scanned when the memory became full.

Copy Cut-off

When making a copy of a document that is longer than the printing paper, use the copy cut-off setting to select whether the remaining part of the document will be cut off or printed on a second page. The initial setting is YES (cut off the remainder). To change the setting, follow the steps below.

-
- 1** Press these keys:



The display will show:

COPY CUT-OFF

-
- 2** Press **1** to set copy cut-off to YES (the remaining part of the document will not be printed), or **2** to set copy cut-off to NO (the remaining part will be printed on a second page).

YES



or

NO



The display will show:

INITIALIZE FILM

-
- 3** Press the **STOP** key to return to the date and time display.

STOP



Making Telephone Calls

Your fax can be used like a regular telephone to make and receive voice calls.

- ◆ To make or receive a phone call, the power must be on.

- 1** Pick up the handset or press the **SPEAKER** key. Listen for the dial tone.

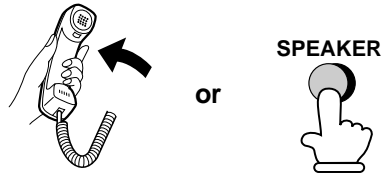

- 2** Dial the number using one of the following methods:

- **Normal Dialling:** Enter the full telephone number with the numeric keys.
- **Rapid Key Dialling:** Press the appropriate Rapid Key.
- **Speed Dialling:** Press the **SPEED DIAL** key, and enter the 2-digit Speed Dial number with the numeric keys.

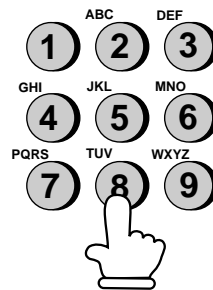

- 3** Speak with the other party when they answer.
 - If you pressed the **SPEAKER** key, pick up the handset to talk.

Comments:

- While the handset of the fax is lifted (off hook), an extension phone connected directly to the fax cannot be used to speak with the other party.
- The fax may interrupt a voice call received on an extension phone if the reception mode is set to A.M. and there is a period of silence during the conversation. If you are on a tone dial phone, you can prevent this by pressing any three keys on the phone immediately after you answer. (Note: Do not enter the code to activate fax reception: 5, ✖, ✖.)

Chain Dialling

After lifting the handset, you can dial any combination of Normal Dialling, Rapid Key Dialling and Speed Dialling numbers. For example, if you have stored an area code or an access code for a special service in a Rapid Key, you can press the Rapid Key for that area code or access code, then dial the remainder of the number by pressing a Rapid Key, pressing number keys, or pressing the **SPEED DIAL** key and entering a two-digit Speed Dial number.

Using the SEARCH/R key

You can use the **SEARCH/R** key to search for a Rapid Key or Speed Dial number. First search for the number as described in *Using the SEARCH/R key in Sending a Fax by Automatic Dialling* in Chapter 3, then pick up the handset or press the **SPEAKER** key. The number will be dialled automatically (do not press the **START/MEMORY** key).

Redial

The last number called can be redialled by pressing the **REDIAL** key (it is not necessary to pick up the handset or press the **SPEAKER** key). When the other party answers, pick up the handset to talk.

Issuing tone signals

If you are on a pulse dial line, you can use the "*" key to temporarily issue tone signals when you press the numeric keys. This allows you to use certain telephone services which require entering tone signals.

When you need to enter one or more tone signals, press the "*" key and then press the appropriate numeric keys.

To change back to pulse mode, simply hang up (the dialling mode automatically changes back to the setting of Option Setting 9 when you hang up).

PBX operations

If your fax is connected to a PBX, you can use it to perform the following operations:

- ◆ **Making enquiry calls:** During a call, you can put the other party on hold, make a further call to a third party, and then go back to your original caller.
- ◆ **Transferring calls:** You can transfer a call to another number on the same PBX without operator assistance.

Your fax is also fully compatible with British Telecom Network Services and Telecom Eireann Phone Plus Services and can be used in conjunction with any facility that requires a recall command.

Note: To perform PBX operations, Option Setting 11 must be set to the appropriate recall mode for your PBX (see Chapter 8, *Optional Settings*). Check your PBX manual or consult your supplier for the correct recall mode. If you are using British Telecom Network Services or Telecomm Eireann Phone Plus Services, Option Setting 11 must be set to time-break recall. (This is the initial factory setting).

Making enquiry calls

-
- 1** During the telephone conversation, press the **SEARCH/R** key. This puts the other party on hold.



-
- 2** When you hear the dial tone, dial the number of the third party for the enquiry call.

-
- 3** When you have finished the enquiry call, you will be automatically returned to the original caller as soon as the third party hangs up.

Transferring calls

-
- 1** During the telephone conversation, press the **SEARCH/R** key. This puts the other party on hold.



-
- 2** When you hear the dial tone, dial the number to which you want to transfer the call. When the other party answers, hang up, and the call will be transferred.

- If the other party does not answer, press the **SEARCH/R** key again to return to the original caller.

Caller ID

If you subscribe to a caller identification service from your telephone company, you can set your fax to display the name and number of the caller while the fax rings.

Important:

- **To use this function, you must subscribe to a caller identification service from your telephone company.**
- Your fax may not be compatible with some caller identification services.
- Caller ID may not function if the machine is connected to a PBX.

1 Press these keys:



The display will show: OPTION SETTING

2 Press the * key three times.



The display will show: CALLER-ID

3 Press **1** to turn on Caller ID, or **2** to turn it off.

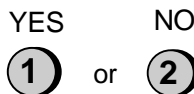

The display will show: COVER SHEET MODE

- 4** Press the **STOP** key to return to the date and time display.



- ◆ Set Option Setting 3 (Number of Rings to Answer) to 2 or more rings (see Chapter 8).

How Caller ID operates

When you receive a call, the name **and/or** phone number of the caller will alternately appear in the display, beginning just before the second ring. The information will continue to be displayed until you pick up the handset, or until the fax answers automatically if it is in FAX mode.

Note: At present most caller-id equipped telephone networks only supply the caller's number, therefore the caller's name will only appear providing that the caller's name and number have been programmed into memory.

Display example:

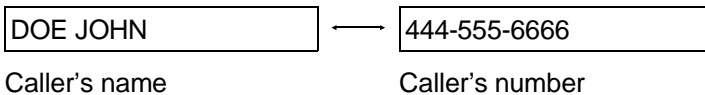

Display messages

One of the following messages will appear while the fax rings if caller information is not available.

NO SERVICE No caller information was received from your telephone company. Make sure that the telephone company has activated your service.

CALLER-ID ERROR Noise on the telephone line prevented reception of caller information.

WITHHELD Caller information was not provided by the telephone company at the caller's request.

Viewing the Caller ID list

If you subscribe to a Caller ID service and have turned on the Caller ID function, your fax machine will keep information on the most recent 20 calls and faxes you have received. You can view this information, which consists of the name and number of each caller, in the Caller ID List.

- ◆ After you have received 20 calls, each new call will delete the oldest call.

Note: At present most caller-id equipped telephone networks only supply the caller's number, therefore the caller's name will only appear providing that the caller's name and number have been programmed into memory.

Follow the steps below to view the Caller ID List in the display. If desired, you can immediately dial a number when it appears.

To print out the list, see Chapter 9, *Printing Reports and Lists*.

-
- 1** Press these keys:

SEARCH



2

The display will show: REVIEWING CALLS

-
- 2** Press the * key to scroll through the list from the most recent call, or the # key to scroll through the list from the oldest call.

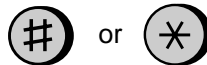

or



3 If you want to dial one of the numbers in the list, scroll through the list until the number appears in the display.

- If you want to send a fax, load the document and then press the **START/MEMORY** key.
- If you want to make a voice call, pick up the handset or press the **SPEAKER** key. Dialing will begin automatically. (If you pressed the **SPEAKER** key, pick up the handset when the other party answers.)



4 Press the **STOP** key when you have finished viewing the list.



To delete calls from the caller list

If you want to delete a single call from the caller list, press the "0" key while the call appears in the display. If you want to delete all calls from the list, hold the "0" key down for at least 3 seconds while you are viewing any number in the list.

Priority Call

If desired, you can set your fax to make a special ringing sound when you receive a call from a designated phone number. This lets you know immediately who is calling without having to look at the display. To use this function, enter the desired phone number by following the steps below (only one phone number can be entered).

- 1** Press the keys shown at right. PRIORITY CALL # will appear in the display.



- 2** Press **1** to enter a number, or **2** to clear a number. (If you pressed **2**, go to Step 4.)

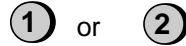

- 3** Enter the phone number, including the area code, by pressing the number keys (max. of 20 digits).

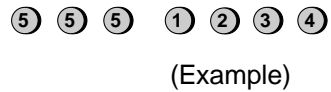

- 4** Press the **START/MEMORY** key and then the **STOP** key.



Note: This facility will not work if the calling party has instructed the telephone network to withhold their Caller ID information.

Blocking voice calls

With Caller ID turned on, you can use the Anti Junk Fax function described in *Blocking Reception of Unwanted Faxes* in this chapter to prevent voice calls as well as fax receptions (the Anti Junk Fax function can normally only prevent faxes).

In this case, when a voice call or a fax transmission comes in from a number you have specified as a "Junk Number", your fax will break the connection as soon as it receives the calling phone number from the caller ID service (before the second ring).

To use this function, set Option Setting 13 to YES as described in Chapter 8, *Option Settings*, and then enter the number in the Anti Junk Number List as explained in *Blocking Reception of Unwanted Faxes* in this chapter.

Note: This function will not block a call from a number which has been entered into the machine as the Priority Call number.

Broadcasting

This function allows you to send the same document to as many as 20 different locations with just one operation. First store the document in memory, then enter the numbers of the receiving machines. The document will be transmitted to each location.

- ◆ You can only use Rapid Keys or Speed Dial numbers to dial the numbers of the receiving machines.

1 Load the document(s).

The display will show:

READY TO SEND

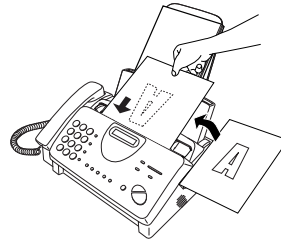

2 Press the **START/MEMORY** key and then **2**.



3 Dial the receiving machines by using one or both of the following methods. (a maximum of 20 stations can be selected).

- Enter one or more Speed Dial numbers by pressing the numeric keys.
- Press one or more Rapid Keys.

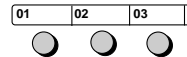

(Example)

4 Press the **START/MEMORY** key.

- Set the resolution and/or contrast if desired.



5 Press the **START/MEMORY** key.
Transmission will begin.

- A Transaction Report is automatically printed out after Broadcasting is completed. Check the "Note" column of the report to see if any of the locations are marked "Busy" or have a communication error code. If so, send the document to those locations again.

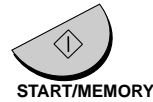

Cover Sheet

You can have the Fax generate a cover sheet and send it as the last page of each of your fax transmissions.

You can select a message.

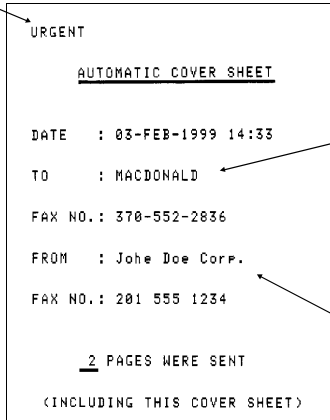

For the recipient's name to appear, you must dial using a Speed Dial or Rapid Key number with the name programmed.

Your name and number must be programmed as explained in Chapter 1.

Follow the steps below to turn on the cover sheet function. Once the cover sheet function is turned on, cover sheets will be included with all transmissions until you turn it off.

1 Press these keys:

FUNCTION



4

The display will show:

OPTION SETTING

2 Press these keys:



The display will show:

COVER SHEET MODE

- 3** Press **1** (YES) to turn on the cover sheet function, or **2** (NO) to turn it off.

YES

NO

The display will show:

1

or

2

AUTO PRINT OUT

- 4** Press the **STOP** key to return to the date and time display.

STOP



Selecting a header message (optional)

When the cover sheet function is turned on, you can also select a message which will appear as a header at the top of the cover sheet. Note that the message selection is only effective for one transmission.

- 1** Load the document(s).
- The document must be loaded before a message can be selected.
 - The cover sheet function must be turned on.

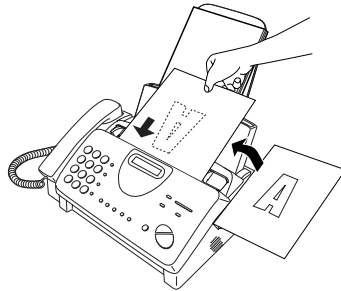

- 2** Press these keys:

FUNCTION

**5**

The display will show:

COVER SHEET HEAD

3 Select a message by entering a number from **1** to **4**:

1: URGENT

2: IMPORTANT

3: CONFIDENTIAL

4: PLS. DISTRIBUTE



(Example)

4 Dial the receiving machine and transmit the document.

Note: To cancel a cover sheet header setting, press the **STOP** key or remove the document from the feeder.

Batch Page Numbering

You can change the page numbering of the transmitted document from simple numbering ("P.01", "P.02", etc.) to batch numbering, which means that a slash and the total number of pages being sent are added after each page number (for example, "P. 01/05", "P.02/05", etc.). This allows the receiver to check for missing pages.

1 Load the document(s).

- The document must be loaded before batch page numbering can be set.

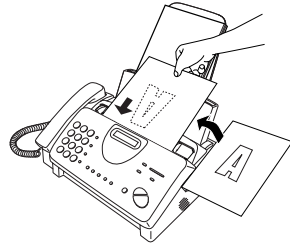

2 Press these keys:

The display will show:

PAGE COUNTER SET

FUNCTION



3 Enter the total number of pages ("01" to "99") by pressing the number keys.

- If you are sending a cover sheet, **do not** include it in the total number of pages (the number will be adjusted automatically).



Example:
Eight pages

4 Dial the receiving machine and transmit the document.

Comments:

- If you need to cancel a batch number entry, remove the document from the feeder or press the **STOP** key.
- If the number of pages actually transmitted does not coincide with the batch number entered, the alarm will sound and **PAGE COUNT ERROR** will appear in the display. **PAGE E.** will also appear in the **NOTE** column of the Transaction Report if it has been set to print out.

Blocking Reception of Unwanted Faxes

The Anti Junk Fax function allows you to block reception of faxes from parties which you specify. This saves paper by not printing out unwanted "junk" faxes.

To use this function, first turn it on by setting Option Setting 13 to YES as explained in Chapter 8, and then enter the fax numbers from which you do not want to receive faxes as shown below.

Comments:

- Up to 5 numbers can be entered in the Anti Junk Number List.
- The Anti Junk function will not operate for a number which has also been stored as a Priority Call number.
- To clear a number from the Anti Junk Number List, you need to know the 1-digit number which identifies it. If you have forgotten this number, print out the Anti Junk Number List as explained in Chapter 9.

-
- 1** Press the keys shown at right.
STORE JUNK # will appear in the display.



-
- 2** Press **1** to store a number in the Anti Junk Number List, or **2** to clear a number from the list.

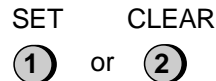

-
- 3** **Storing:** Enter a 1-digit number from 1 to 5. This number identifies the fax/voice number you will store in the next step.



(Example)

Clearing: Enter the number which identifies the fax/voice number you want to clear, and go to Step 5.

4 Enter the full number you want to block (max. of 20 digits).



(Example)

5 Press the **START/MEMORY** key.



6 Return to Step 3 to enter (or clear) another number, or press **STOP** to exit.

Step 3 or



Sending Documents From Memory

With this function, the original document is scanned immediately, stored in memory, and then transmitted once the connection to the receiving machine is made. This is convenient when transmitting to places where the line is often busy, as it saves you from waiting to pick up the original document and frees the feeder for other operations. After transmission, the document will be cleared from memory.

- ◆ Only one memory transmission can be set at a time.
- ◆ The amount of memory currently occupied appears as a percentage in the display while the document is being scanned.

1 Load the document(s).

The display will show:

READY TO SEND

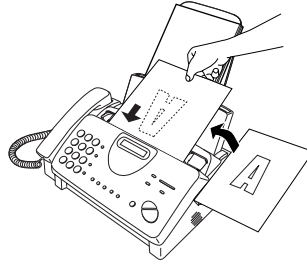

- Set the resolution and/or contrast if desired.



2 Press the **START/MEMORY** key and then **1**.

The display will show:

ENTER STATION #



3 Enter the number of the receiving machine using one of the following methods:

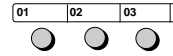

- Press a Rapid Key.
- Press the **SPEED DIAL** key and enter a Speed Dial number.
- Enter a full telephone number by pressing the number keys.

(Example)

4 Press the **START/MEMORY** key if you entered a Speed Dial number or a full number.



- The document will be scanned and stored in memory. Your fax will then dial the receiving machine and transmit the document (redialling will be done automatically if necessary).

If the memory becomes full...

If the memory becomes full while the document is being scanned, MEMORY IS FULL will appear in the display.

- ◆ Press the **START/MEMORY** key if you want to transmit the pages which have been stored up to that point in memory. The remaining pages will be ejected from the feeder. After transmission, the memory will be cleared and you can transmit the remaining pages. You will also need to transmit the page which was being scanned when the memory filled up.
- ◆ Press the **STOP** key if you want to cancel the entire transmission.

Polling (Requesting a Fax Transmission)

Polling allows you to call another fax machine and have it send a document (previously loaded in its feeder) to your machine without operator assistance. In other words, the receiving fax machine, not the transmitting fax machine, initiates the transmission. You can use your machine to both poll and be polled by others.

To use the polling function, you must first set Rapid Key 05/POLL for use as a polling key. This is done by changing Option Setting 14, as described in Chapter 8, *Option Settings*. (Note that when Rapid Key 05/POLL is set as a polling key, it cannot be used for Rapid Key Dialling.)

Requesting transmission

Note: Rapid Dial Keys cannot be used for polling. To dial a Rapid Dial location, press the **SPEED DIAL** key and then enter the 2-digit number corresponding to the Rapid Key.

1 Dial the fax machine you want to poll using one of the following methods:

- Pick up the handset (or press the **SPEAKER** key) and dial the full number. Wait for the fax answerback tone.
- Press the **SPEED DIAL** key and enter a 2-digit Speed Dial number.
- Enter the full number using the numeric keys.

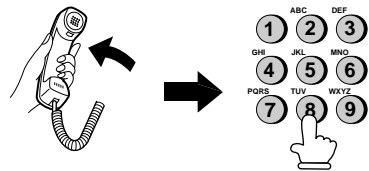

(Example)

2 Press Rapid Key 05/POLL.

- If you used the handset, replace it when POLLING appears in the display. Reception will begin.

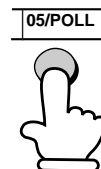

Being polled (polling standby)

To let another fax machine poll your machine, simply set the reception mode to FAX, and load the document(s) to be sent.

Transmission will take place when the other fax machine calls your machine and activates polling. Automatic reception is possible whilst your fax is on polling standby.

Polling security

Polling Security allows you to prevent unauthorized polling of your machine. When this function is turned on, polling will only take place when the fax number of the polling fax machine has been entered in your machine's list of permitted fax numbers (called "passcode numbers"). The number of the polling fax must also be correctly programmed into itself for identification.

To use Polling Security, follow the steps below to turn the function on, and then enter permitted numbers as shown on the following page.

-
- 1** Press the keys shown at right. ENTRY MODE will appear in the display.



-
- 2** Press the # key three times. SECURITY SELECT will appear in the display.



-
- 3** Press **1** to turn polling security on, or **2** to turn it off.

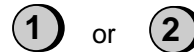



















-
- 4** Press the **START/MEMORY** key and then the **STOP** key.



Storing and clearing fax numbers for polling permission

You can store up to 10 fax numbers in your machine's list of permitted numbers.

-
- 1** Press the keys shown at right.
ENTRY MODE will appear in the display.
- FUNCTION  **3**
-
- 2** Press the # key four times.
PASSCODE # MODE will appear in the display.
-    
-
- 3** Press **1** to store a number, or **2** to clear a number.
-  or 
-
- 4** **Storing:** Enter a 2-digit number from 01 to 10. This number identifies the fax number you will store in the next step.
-  
- (Example)
- Clearing:** Enter the number which identifies the fax number you want to clear, and go to Step 6.
-
- 5** Enter the fax number (max. of 20 digits).
-       
- (Example)
-
- 6** Press the **START/MEMORY** key.
- 
START/MEMORY
-
- 7** Return to Step 4 to enter (or clear) another number, or press **STOP** to exit.
- Step 4 or 

Timer Operations

The Timer function allows you to set a transmission and/or polling operation to be performed automatically at a time you specify. One transmission operation and one polling operation can be set at the same time, and the times they will be performed can be specified up to 24 hours in advance.

As an example, you can use this function to take advantage of off-peak telephone rates without having to be there when the operation is performed.

Note: Only a Speed Dial number can be used to dial the receiving machine.

Setting a timer operation

-
- 1** Press the keys shown at right. **TIMER MODE** will appear in the display.

FUNCTION



-
- 2** Press # to set a transmission operation (**SEND MODE**), or * to set a polling operation (**POLLING MODE**).



or



-
- 3** Press 1 to select **SET**.



-
- 4** Enter the time at which you want the operation to take place in 24-hour format (2 digits for the hour and 2 digits for the minute).





Example: 9:25

-
- 5** Press the **START/MEMORY** key.





START/MEMORY

- 6** Enter the Speed Dial number of the receiving fax machine.
- If this is a polling operation, go to Step 9.
-   (Example)



- 7** Press the **START/MEMORY** key.
- 
START/MEMORY

- 8** Adjust the resolution and/or contrast if desired (skip to the next step if you don't want to change settings).
- RESOLUTION

- 9** Press the **START/MEMORY** key and then the **STOP** key. If this is a transmission operation, load the document in the feeder sometime before the specified time of transmission.
-  
START/MEMORY STOP

To cancel an operation

If you need to cancel an operation after it has been set, follow the steps below.

- 1** Press the keys shown at right. **TIMER MODE** will appear in the display.
- FUNCTION  

- 2** Press **#** to cancel a transmission operation, or ***** to cancel a polling operation.
-  or 

- 3** Press **2** to select CLEAR.
- 

- 4** Press the **START/MEMORY** key and then the **STOP** key.
-  
START/MEMORY STOP

Option Settings

The option settings let you customise your fax to better suit your needs. An initial setting has been made for each option at the factory. You can change a setting by following the steps described for each option below.

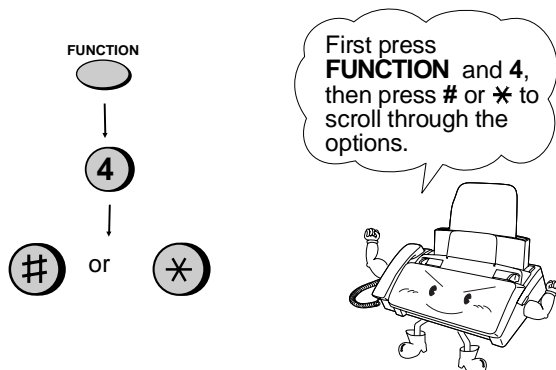

Setting 1: FINE RESOLUTION PRIORITY

This option sets the default resolution (the resolution used if a setting is not made with the **RESOLUTION** key) for transmitting documents. Press **1** (YES) to set the default resolution to FINE, or **2** (NO) to set it to STANDARD.

- Initial setting: 2

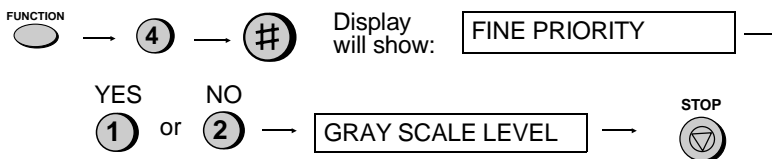

Setting 2: GREY SCALE SETTING

This sets the grey scale used for the **HALF TONE** resolution setting. Press **1** for 16 levels (this gives lower quality and faster transmission) or **2** for 64 levels (this gives higher quality and slower transmission).

- Initial setting: 2

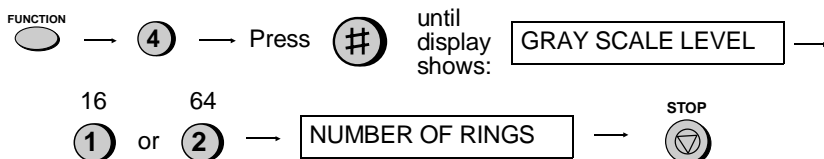

Setting 3: NUMBER OF RINGS AUTO RECEPTION

This sets the number of rings your fax allows before answering an incoming call in FAX and TEL/FAX reception modes. Enter any number from **1** to **5**.

- Initial setting: **1**

**Setting 4: RECALL INTERVAL**

This sets the amount of time your fax will wait between automatic redials when the line is busy. Enter **01** for 1 minute, **02** for 2 minutes, etc., up to a maximum of **15** minutes.

- Initial setting: **05**

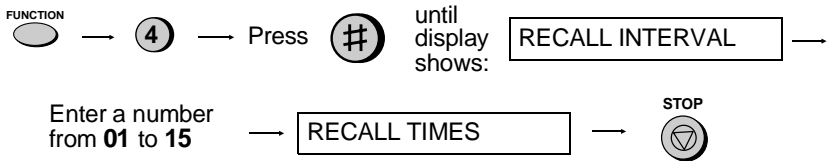
**Setting 5: RECALL TIMES**

This sets the maximum number of times your fax will automatically redial if the line is busy. Enter any number from **00** to **04**. (In Eire, enter any number from **00** to **03**).

- Initial setting: **02**

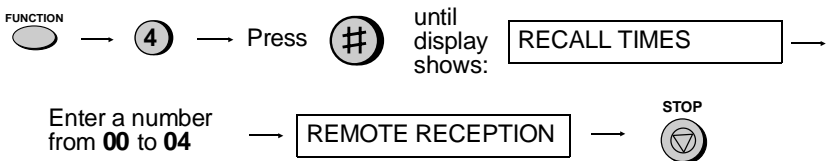

Setting 6: TEL/FAX REMOTE NUMBER (TRANSFER CODE)

If you hear a fax tone when you answer a call on a tone dial extension phone connected to the same line as the fax, you can make the fax begin reception by pressing **5**, *****, and ***** on the phone. Use this setting if you want to use a number other than **5** to begin fax reception. You can enter any number from **0** to **9**.

- Initial setting: **5**

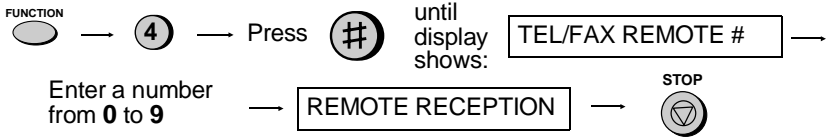

Setting 7: REMOTE RECEPTION SELECT

If you don't intend to use the above TEL/FAX REMOTE NUMBER, you can turn detection of the number off. This will ensure that the fax never mistakenly attempts to begin reception if it detects a signal similar to the TEL/FAX REMOTE NUMBER while you are talking on an extension phone. Press **1** to turn detection on, or **2** to turn detection off.

- Initial setting: **1**

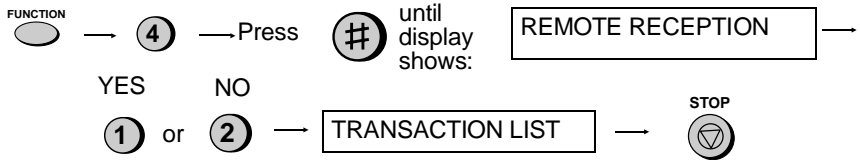

Setting 8: TRANSACTION REPORT PRINT SELECT

This sets the condition for printing out a Transaction Report. Enter a number from **1** to **5** as follows:

- 1 (ALWAYS PRINT):** A report will be printed after each transmission, reception, or error.
- 2 (ERR/TIMER/MEM):** A report will be printed after an error, timer operation, or memory operation.
- 3 (SEND ONLY):** A report will be printed only after a transmission.
- 4 (NEVER PRINT):** A report will never be printed.
- 5 (ERROR ONLY):** A report will be printed only after an error occurs.

- Initial setting: **3**

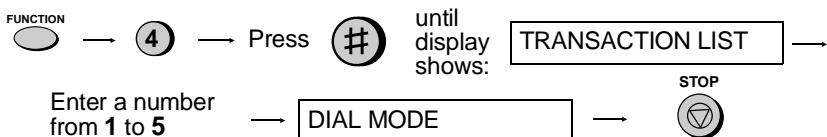

Setting 9: DIAL MODE

This sets the mode of dialling. Press **1** if you are on a tone dial line, or **2** if you are on a pulse dial line.

- Initial setting: **1**

**Setting 10: PSEUDO RINGING DURATION**

This sets the duration of pseudo ringing when the reception mode is set to TEL/FAX. Enter a number from **1** to **4** as follows:

Eire: Settings **3** and **4** are not available.

1 (15 SEC.):	15 seconds
2 (30 SEC.):	30 seconds
3 (60 SEC.):	60 seconds
4 (120 SEC.):	120 seconds

- Initial setting: **1**

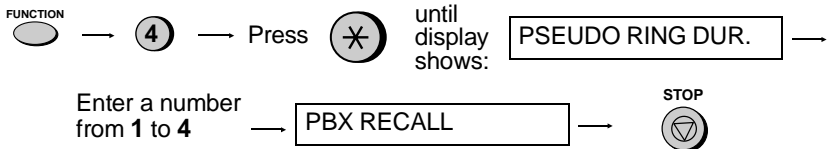

Setting 11: PBX RECALL

This sets the recall mode used for transferring calls on a PBX or utilising BT Network services. Refer to your PBX manual or consult your supplier for the correct setting if the factory setting is inappropriate. Enter **1** for earth recall, **2** for time break recall, or **3** for no operation.

- 1: Earth
- 2: Time break recall
- 3: No operation

• Initial setting: 2

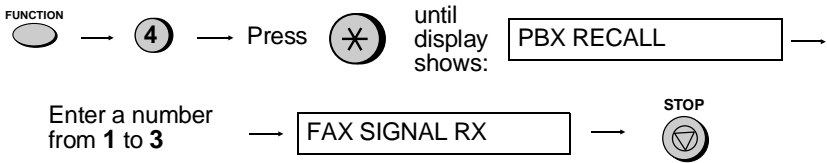

Setting 12: FAX SIGNAL RECEIVE

Your fax will automatically begin reception if you hear a high-pitched fax tone after answering a call. If you use a computer fax modem on the same line, you must turn this function off in order to prevent your fax from mistakenly attempting to receive documents sent from the computer fax modem. Press **1** to turn the function on, or **2** to turn it off.

• Initial setting: 1

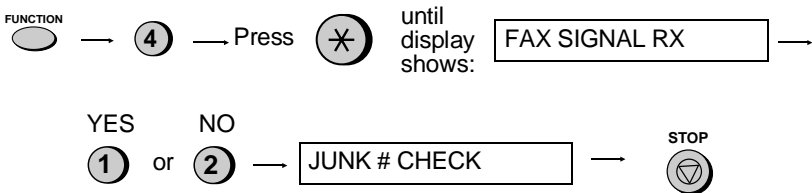

Setting 13: JUNK NUMBER CHECK

Press **1** to prevent reception from fax numbers entered in the Anti Junk Number List. Press **2** to allow reception from all numbers.

- Initial setting: **2**

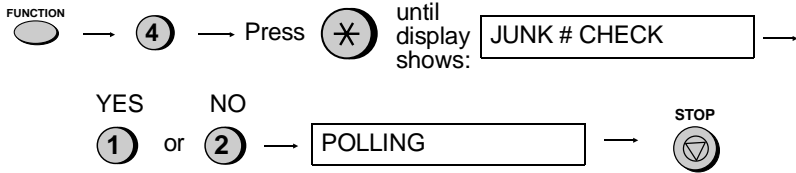
**Setting 14: POLLING**

Press **1** if you want to use Rapid Key 05/POLL as a polling key. Press **2** if you want to use it as a regular Rapid Key.

- Initial setting: **2**

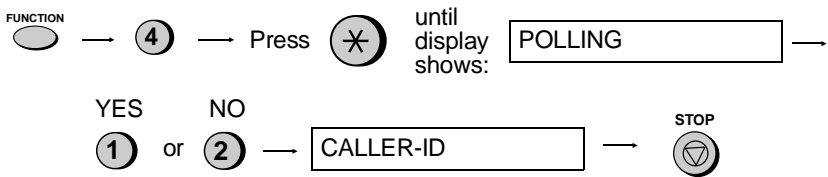
**Setting 15: CALLER ID**

If you subscribe to a caller ID service and want to use the Caller ID function, press **1**. To turn Caller ID off, press **2**. (Caller ID is explained in more detail in *Caller ID* in Chapter 7.)

- Initial setting: **2**

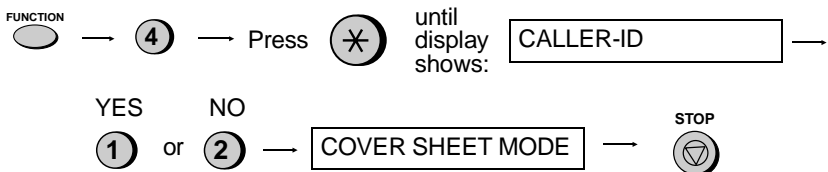

Setting 16: AUTO COVER SHEET

Press **1** (YES) to have the fax automatically generate a cover sheet and send it as the last page of each transmission. Press **2** (NO) to turn the function off.

- Initial setting: **2**

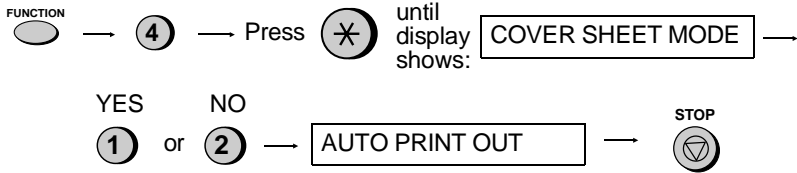

Setting 17: ACTIVITY REPORT AUTO PRINT OUT

Press **1** to have your fax automatically print out an Activity Report once every 30 operations. (The list can still be printed out on demand when desired.) Press **2** to turn automatic print-out off.

- Initial setting: **2**

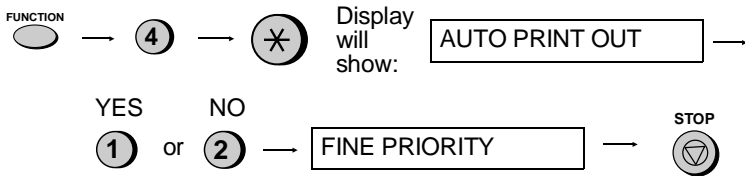

Printing Reports and Lists

You can print out lists showing settings and information entered in the fax. You can also have the fax automatically print out a report on transactions after they are made. The lists and the report are described below.

Printing a list

- 1 Press these keys:

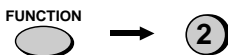

The display will show: LISTING MODE

- 2 Press the # key or the * key until the desired list appears in the display.

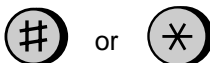

- 3 Press the **START/MEMORY** key.



Activity Report

This report shows information on your most recently performed send and receive operations (a combined maximum of 30 operations can appear). The report is divided into two parts: the **TRANSMISSIONS ACTIVITY REPORT**, which shows information on transmissions, and the **RECEPTIONS ACTIVITY REPORT**, which shows information on receptions.

- ◆ If Option Setting 17 (Auto Print Out) is set to YES, a report will be automatically printed out whenever information on 30 operations has accumulated. (A report can still be printed on demand at any time.)
- ◆ All information is erased after a report is printed out. If automatic print-out is disabled and print-out has not been performed manually for 30 operations, the information on the oldest operation will be overwritten each time a new operation is performed.

```

*****
*
*                               TRANSMISSIONS ACTIVITY REPORT
*
*                               FOR: John Doe Corp.           201 555 1234
*                               03-FEB-1999 03:51
*
+-----+-----+-----+-----+-----+-----+
|NO.| DATE | START | RECEIVER | TX TIME | PAGES | TYPE | NOTE |
+-----+-----+-----+-----+-----+-----+
* 1 03-FEB 03:34 | N.Y. | 41" | 1 | SEND | OK |
* 2 03-FEB 03:35 | | 1'21" | 2 | BROADCAST | |
* 3 03-FEB 03:38 | JACK SMITH | 58" | 2 | SEND(M) | OK |
* 4 03-FEB 03:45 | JACK SMITH | 48" | 1 | TIMER SEND | OK |
+-----+-----+-----+-----+-----+-----+
*                               TOTAL | 3'41" | 6 |
*
*                               GRAND TOTAL TIME: | 4M 21S |
*                               PAGES: | 7 |
*
*****

```

Explanation of headings

SENDER/RECEIVER The fax number of the other machine involved in the transaction. In the case of a transmission, the number dialed appears. In the case of a reception, the programmed ID of the sending machine appears. If this machine does not have an ID function, the communication mode will appear (for example, "G3").

PAGES Number of pages transmitted or received.

NOTE **OK** - Transmission/reception was normal.

P.FAIL - A power failure occurred. If you have power and the problem persists, try a different outlet. If necessary, have an electrician check your power lines.

JAM - A problem with the paper or original document occurred. Make sure the paper or document is loaded properly. Make sure the operation panel is shut securely.

NO PAPER - You ran out of paper during reception.

COME-0 to COME-7 - A telephone line error prevented the transaction. See *Line Error* in Chapter 11.

CANCEL - Transmission was cancelled because the **STOP** key was pressed, no document was in the feeder, or the other machine requested transmission using a function which your fax does not have. If you were attempting to fax, make sure a document is in the feeder. If you were receiving, contact the faxing party to see how they are trying to send to you.

Timer List

This list shows the timer operations which are currently set.

TIMER LIST		
FOR: Johe Doe Corp.		03-FEB-1999 02:46 201 555 1234
<hr/>		
TIMER SEND		
START	05:15	
RECEIVER	N.Y.	
RESOLUTION	FINE	:AUTO
<hr/>		
TIMER POLLING		
START	10:00	
SENDER	JACK SMITH	
<hr/>		

Telephone Number List

This list shows the fax and voice numbers which have been stored for automatic dialling.

TELEPHONE NUMBER LIST		
FOR: Johe Doe Corp.		03-FEB-1999 14:07 201 555 1234
<hr/>		
SPEED NO.	NAME	TELEPHONE NO.
01	N.Y.	123-786-6340
02	JACK SMITH	125-563-8462
03	ANDERSON	230-347-6385
04	JANE	812-937-0142
05	MACDONALD	370-552-2836
<hr/>		

Passcode List

This list shows settings made for polling security, your name and fax/telephone number as entered in the machine, and a sample of the header printed at the top of every page you transmit (**HEADER PRINT**).

PASSCODE LIST		
FOR: Jone Doe Corp.		23-MAR-1999 13:14
201 555 1234		
POLLING MODE	SECURITY OFF	
PASSCODE NO.	01 1237056340	
	02 1255630462	
	03	
	04	
	05	
	06	
	07	
	08	
	09	
	10	
PRIORITY CALL NO.	2015560267	
SENDER'S NAME		
Jone Doe Corp.		
SENDER'S TELEPHONE NUMBER		
201 555 1234		
HEADER PRINT		
23-MAR-1999 13:14	Jone Doe Corp.	201 555 1234 P.01

Option Setting List

This list shows the current status of the option settings.

OPTIONS SETTING LIST		
FOR: Jone Doe Corp.		03-FEB-1999 14:02
201 555 1234		
NO.	ITEM	SETTING
1	FINE PRIORITY	NO
2	GRAY SCALE LEVEL	64LEVEL
3	NUMBER OF RINGS	1 RING
4	RECALL INTERVAL	05 MINUTES
5	RECALL TIMES	02 TIMES
6	TEL/FAX REMOTE NO.	<5>**
7	REMOTE RECEPTION	YES
8	TRANSACTION PRINT SELECT	SEND ONLY
9	DIAL MODE	TONE
10	PSEUDO RINGING DURATION	15S
11	PBX RECALL	TIME BREAK
12	FAX SIGNAL RX	YES
13	JUNK NUMBER CHECK	NO
14	POLLING	NO
15	CALLER-ID	NO
16	COVER SHEET	NO
17	AUTO PRINT OUT	NO

Anti Junk Number List

This list shows the numbers that are blocked by the Anti Junk function.

ANTI JUNK NUMBER LIST	
03-FEB-1999 14:11	
ANTI JUNK NUMBER CHECK : NO	
STORED LOCATION	JUNK FAX NUMBER
1	2015546621
2	2014573321
3	1023570251

Caller ID List

This list shows information about your most recent calls (maximum of 20 calls). (This list is only available if you are using the Caller ID function.)

CALLER-ID LIST				
03-FEB-1999 14:24				
FOR: Johe Doe Corp.		201 555 1234		
NO.	DATE	RX TIME	NAME	TELEPHONE NO. MODE
01	03-FEB	14:18	JONES JENNIFER	1044567090 FAX
02	03-FEB	14:22	ANDERSON ALLEN	2015551211 TEL
03	03-FEB	14:23	ANDERSON ALLEN	2015551211 A.M.

A.M. Program List

This list shows the settings and codes programmed for the answering machine.

A.M. PROGRAM LIST	
FOR: John Doe Corp.	03-FEB-1999 14:02 201 555 1234
ITEM	CONTENT
OGM RECORDING	GENERAL: RECORDED
TOLL SAVER	YES
RECORDING TIME	4 MIN.
REMOTE CODE NO.	111
OVERRIDE CODE NO.	222
TRANSFER TELEPHONE NO.	201-555-3456
TRANSFER TELEPHONE CALLING	NO
ON A.M. FAILURE	NO
<UNIT SETS TO AUTO FAX RCV.>	
CPC DETECTION	YES
OGM ONLY MODE	NO

Message List

This list shows information about the messages currently recorded in the answering machine, including the date and time of recording, the length, and the type (ICM or memo).

MESSAGE LIST				
FOR: John Doe Corp.		03-FEB-1999 14:06 201 555 1234		
NO.	RECORDED TIME	MESSAGE LENGTH	TYPE	
01	03-FEB 14:00	04"	MEMO	
02	03-FEB 14:04	08"	ICM	

Print Setup List

This list shows the current status of the printing settings accessed by pressing the **FUNCTION** key and the **6** key.

PRINT SET UP LIST		
FOR: Johe Doe Corp.		03-FEB-1999 14:07
		201 555 1234
NO.	ITEM	SETTING
1	INITIALIZE FILM	03-FEB-1999
2-1)	RECEPTION RATIO	AUTO
2-2)	PRINTING RATIO IN MEMORY FULL	93%
3	2 IN 1 PRINT	NO
4	PRINT CONTRAST	NORMAL
5	COPY CUT OFF	YES

Transaction Report

This report is printed out automatically after an operation is completed to allow you to check the result. The fax is set at the factory to print out the report after every transmission, but you can change the setting to have it printed out under a variety of other conditions. This is done by changing Option Setting 8 as described in Chapter 8.

- ◆ The same headings appear in the Transaction Report as in the Activity Report. See *Activity Report* in this chapter for an explanation of the headings.
- ◆ The Transaction report cannot be printed out manually.

Maintenance

Fax print head

Clean the printing head frequently to assure optimum printing performance.

- 1 First unplug the telephone line, then unplug the power lead.

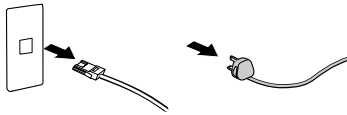

- 2 Pull the paper release plate forward and remove the paper.

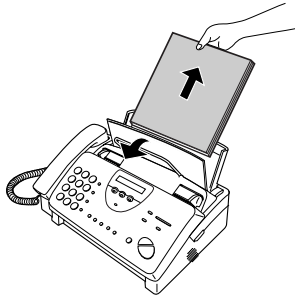

- 3 Open the operation panel (grasp the finger hold and pull up), and then pull the release on the right side of the machine forward to open the print compartment cover.

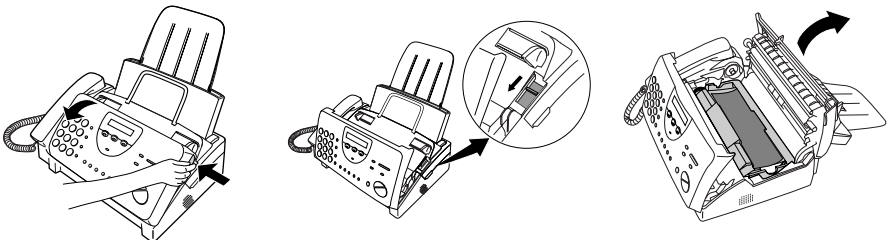

- 4 Take the imaging film cartridge out of the print compartment and place it on a sheet of paper.

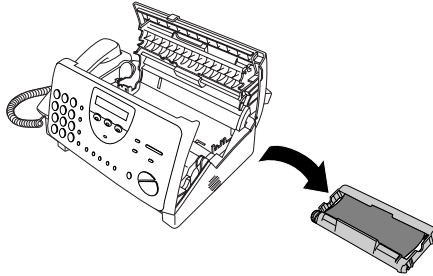

- 5 Wipe the print head and roller with isopropyl alcohol.

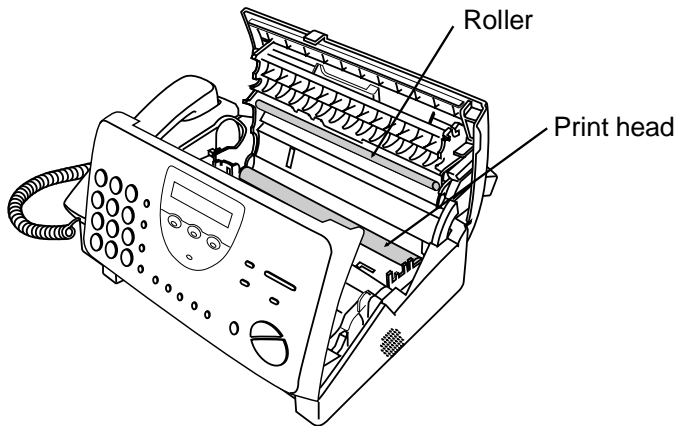

Caution!

- Do not use benzene or thinner. Avoid touching the print head with hard objects.
- The print head may be hot if your fax machine has just received a large number of documents. If this is the case, allow the print head to cool prior to cleaning.

- 6** Place the imaging film cartridge back in the print compartment.

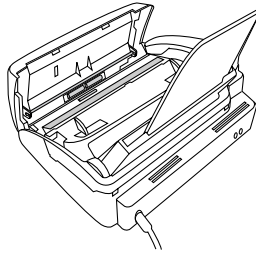

- 7** Gently close the print compartment cover (press down on both sides to make sure it clicks into place), and then close the operation panel.

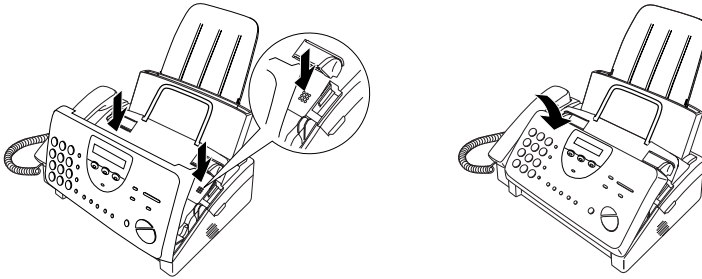

- 8** Reinsert the paper in the paper tray and push the paper release plate back down.

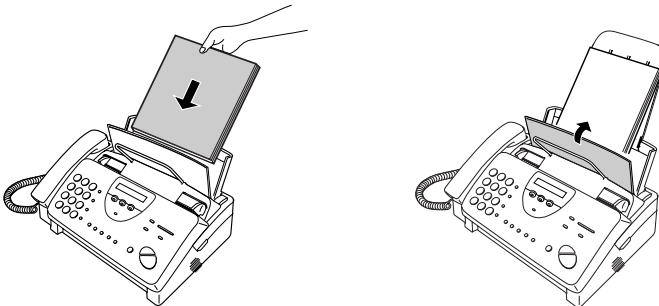

Scanning glass and rollers

Clean the scanning glass and rollers frequently to ensure the quality of transmitted images and copies. Open the operation panel (grasp the finger hold and pull up), and wipe the scanning glass and rollers with a soft cloth.

- ◆ Make sure that all dirt and stains (such as correcting fluid) are removed, as dirt and stains will cause vertical lines on transmitted images and copies.
- ◆ Adhesive cellophane tape is useful for removal of debris from the rollers. (Take care not to leave any pieces of tape on the rollers.)

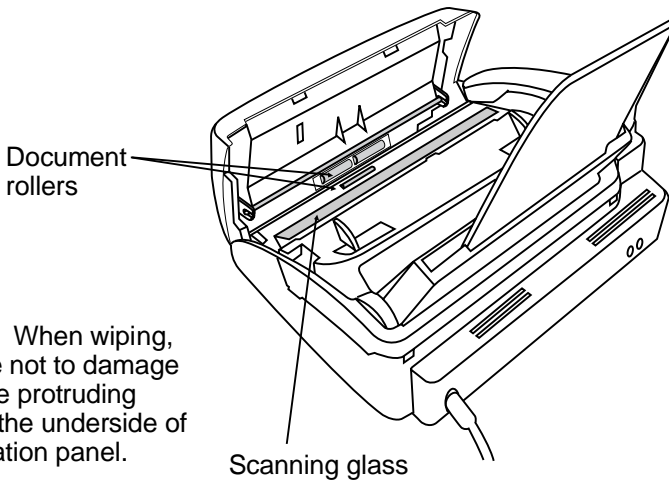

Caution: When wiping, take care not to damage any of the protruding parts on the underside of the operation panel.

The housing

Wipe the external parts and surface of the machine with a dry cloth.

Caution!

- Do not use benzene or thinner. These solvents may damage or discolour the machine.

Troubleshooting

Problems and Solutions

Line error

Problem	Check and remedy
<p>LINE ERROR appears in the display and/or a transaction report is printed out with COM. E- and a number from 0 to 1, 2, 3, 4, 5, 6, or 7 in the NOTE column.</p>	<ul style="list-style-type: none"> • Try the transaction again. If the error persists, check the following: • Check the connection. The cord from the TEL. LINE socket to the wall socket should be no longer than two meters. • Make sure there are no modem devices sharing the same telephone line. • Check with the other party to make sure their fax machine is functioning properly. • Have your telephone line checked for line noise. • Try connecting your fax to a different telephone line. • If the problem still occurs, your fax machine may need service.

Dialing and transmission problems

Problem	Check and remedy
<p>No dial tone when you pick up the handset or press the SPEAKER key.</p>	<ul style="list-style-type: none"> • Make sure the handset cord is connected to the correct socket. See <i>Handset</i> in <i>Connections</i> in Chapter 1.
<p>Dialling is not possible.</p>	<ul style="list-style-type: none"> • Make sure the power cord is properly plugged into a power outlet. • Make sure that the telephone line is properly connected to both the TEL. LINE socket and the wall socket.

	<ul style="list-style-type: none"> • Make sure that the fax is set to the correct dialling mode for your telephone line. See Option Setting 9 in Chapter 8.
The power is on, but no transmission takes place.	<ul style="list-style-type: none"> • Make sure that the receiving machine has fax paper. • Make sure that the telephone line cord is plugged into the TEL. LINE socket, and not the TEL. SET socket. • If the receiving machine is in manual mode with no attendant, reception will not be possible. • If the receiving machine is not a Sharp model, make sure it is G3 compatible. • Check the display for error messages. • Pick up the handset and check for a dial tone. Call the receiving machine by normal (manual) dialling, and confirm its response.
Nothing is printed at the receiving end.	<ul style="list-style-type: none"> • Make sure that the document for transmission is placed face down in the feeder.
A distorted image is received at the other end.	<ul style="list-style-type: none"> • Noise on the telephone line may cause distortion. Try sending the document again. • Make a copy of the document on your fax. If the copy is also distorted, your fax may have a problem. If the problem persists, call for service.

Reception and copying problems

Problem	Check and remedy
The power is on, but no reception takes place.	<ul style="list-style-type: none"> • Make sure the wall socket is connected to the TEL. LINE socket, and not the TEL. SET socket.
The printing paper comes out blank when you try to receive a document.	<ul style="list-style-type: none"> • Make sure that the document is loaded properly in the feeder of the transmitting machine. Print a report or make a copy to confirm the printing ability of your machine.

Problems and Solutions

General print quality is poor.	<ul style="list-style-type: none">• It is important to select a paper that is appropriate for the thermal transfer printer in your fax. We recommend using laser quality paper that has a very smooth finish. Copier paper will work, but it sometimes tends to yield a lighter print quality.
The received document is faint.	<ul style="list-style-type: none">• Ask the other party to send higher contrast documents. If the contrast is still too low, your fax may have a problem. Print a report or make a copy to check your fax's printing ability.
Received images are distorted.	<ul style="list-style-type: none">• Noise on the telephone line may cause distortion. Have the other party try sending the document again.• The print head may be dirty. See <i>Fax print head</i> in Chapter 10.• Make a copy of another document on your fax. If the copy is also distorted, your fax may have a problem. If the problem persists, call for service.
The quality of copies is poor and/or black spots appear.	<ul style="list-style-type: none">• Any dirt or material on the scanning glass will cause spots to appear on copies and transmitted faxes. Clean the fax print head and the scanning glass as explained in Chapter 10.
Reception/copying is interrupted.	<ul style="list-style-type: none">• If reception or copying takes place continuously for a long time, the print head may overheat. Turn off the power and let it cool down.
A received document or copy prints out in strips.	<ul style="list-style-type: none">• Make sure the operation panel and the printer compartment cover under the operation panel are completely closed (press down on both sides of each). (To close the printer compartment cover, grasp the top of the operation panel and pull to open it, and then press down on both sides of the printer compartment cover.)

General problems

Problem	Check and remedy
Information cannot be programmed in the fax.	<ul style="list-style-type: none"> • Make sure the fax is plugged in and the imaging film and paper have been loaded. (Programming is not possible if the imaging film and printing paper have not been loaded.) See <i>Loading the Imaging Film</i> and <i>Loading Printing Paper</i> in Chapter 1.
Nothing appears in the display.	<ul style="list-style-type: none"> • Make sure the power cord is properly plugged into a power outlet. • Connect another electrical appliance to the outlet to confirm that it has power.
The machine does not respond when you press any of its keys.	<ul style="list-style-type: none"> • If a beep sound is not made when you press the keys, unplug the power cord and then plug it back in several seconds later.
Automatic document feeding does not work for transmission or copying.	<ul style="list-style-type: none"> • Check the size and weight of the document (see <i>Transmittable documents</i> in Chapter 3).
Voice calls taken on an extension phone are interrupted by the fax.	<ul style="list-style-type: none"> • The fax may interrupt during a voice call if the reception mode is set to A.M. To prevent interruption on a tone dial extension phone, press any three keys on the extension phone after answering. (Note: Do not enter the code to activate fax reception.)
No reception occurs when polling is attempted.	<ul style="list-style-type: none"> • Make sure you have not run out of paper. • Make sure the transmitting machine is in automatic reception mode. • If the transmitting machine has polling security, make sure that your fax number has been entered both in your machine and in the transmitting machine.

Messages and Signals

Display messages

Note: If you have turned on the Caller ID function, see *Caller ID* in Chapter 7 for display messages related to Caller ID.

A.M. TRANSFER	The answering machine's transfer function has been turned on as explained in <i>Transfer Function</i> in Chapter 2.
COVER OPEN	The print compartment cover (under the operation panel) is open. Open the operation panel (grasp the top and pull toward you), and then press down firmly on both sides of the print compartment cover to close it.
DOCUMENT JAMMED	The original document is jammed. See the following section, <i>Clearing Paper Jams</i> .
FAX RX IN MEMORY	A fax has been received in memory because the imaging film needs replacement, you have run out of printing paper, or the paper is jammed. The fax will print out automatically when the problem is fixed.
FILM END	The imaging film may need replacement. Check the film and replace if necessary.
FUNCTION MODE	The FUNCTION key has been pressed.
LINE ERROR	Transmission or reception was not successful. Press STOP to clear the message, and then try again. If the error persists, see <i>Line Error</i> in <i>Problems and Solutions</i> in this chapter.
LINE IS IN USE	An extension phone connected to the fax is being used. Do not lift the fax's handset or attempt transmission at this time, as this will interrupt the conversation on the extension phone.

MEMORY IS FULL	The memory is full. This may occur during fax reception if too much data is received before the pages can be printed out. If faxes have been received to memory because printing is not possible (an additional message will indicate the problem), resolve the problem so that printing can continue (see <i>Substitute Reception to Memory</i> in Chapter 4). If you are attempting to transmit from memory, see <i>Sending Documents from Memory</i> in Chapter 7.
MEMORY PRINTING	The fax is preparing or printing out a document from memory.
NO DATA	This appears if you attempt to search for an automatic dialling number when none have been stored.
NO # STORED	You have tried to dial or clear a Rapid Key or Speed Dial number that hasn't been programmed (a full number hasn't been assigned to it).
OUT OF PAPER	You are out of printing paper (or the paper release plate is open). Load paper as described in <i>Loading Printing Paper</i> in Chapter 1.
ON HOOK DIAL	The SPEAKER key has been pressed and the fax is waiting for you to dial. (To return to the date and time display, press the SPEAKER key again.)
OVER HEAT	The print head has overheated. Operation may be continued once it cools.
PAPER JAMMED	The printing paper is jammed. See the following section, <i>Clearing Paper Jams</i> .
READY TO SEND	A document has been loaded and the fax is waiting for transmission or copying instructions.
RECALLING	This appears if you attempt to send a fax by automatic dialling and the line is busy or the receiving fax machine does not answer. Your fax machine will automatically reattempt the call. (See <i>Automatic Redialling</i> in <i>Sending a Fax by Automatic Dialling</i> in Chapter 3.)

Display Messages

SEARCH DIAL	The SEARCH/R key has been pressed. Press # or * to search for an automatic dialling number, or press STOP to return to the data and time display. (See <i>Using the SEARCH/R key in Sending a Fax by Automatic Dialling</i> in Chapter 3.)
TOTAL PAGE(S) 01	Number of pages transmitted, received, or copied.

Audible signals

Continuous tone	3 seconds	Indicates the end of transmission, reception, or copying.
Intermittent tone (3 beeps)	5 seconds (1 second on, 1 second off)	Indicates incomplete transmission, reception, or copying.
Rapid intermittent tone	35 seconds (0.7 seconds on, 0.3 seconds off)	Indicates that the handset is off hook.

Clearing Paper Jams

Clearing a jammed document

If the original document doesn't feed properly during transmission or copying, or DOCUMENT JAMMED appears in the display, first try pressing the **START/MEMORY** key. If it doesn't feed out, remove it as follows:

Important:

Do not try to remove a document without opening the operation panel. This may damage the feeder mechanism.

- 1 Open the operation panel by grasping the finger hold and pulling up.

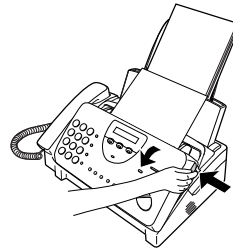

- 2 Remove the document.

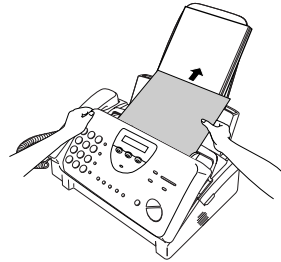

- 3 Close the operation panel, making sure it clicks into place.

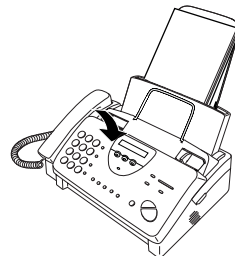

Click!

Clearing jammed printing paper

- 1** Pull the paper release plate forward and remove the paper.

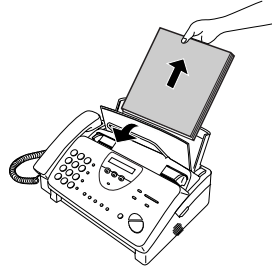

- 2** Open the operation panel (grasp the finger hold and pull up), and then pull the release on the right side of the machine forward to open the print compartment cover.

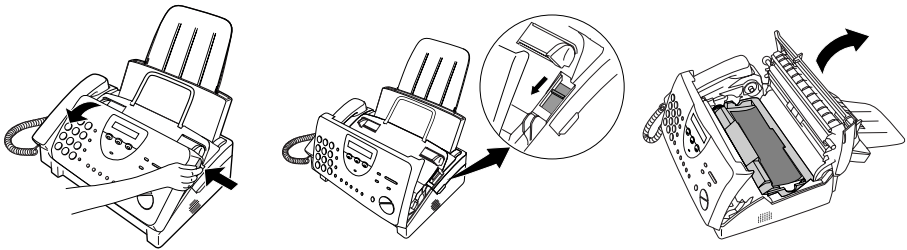

- 3** Gently pull the jammed paper out of the machine, making sure no torn pieces of paper remain in the print compartment or rollers.

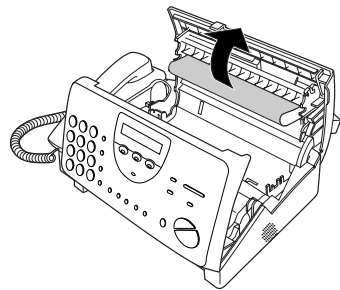

-
- 4** Gently close the print compartment cover (press down on both sides to make sure it clicks into place), and then close the operation panel.

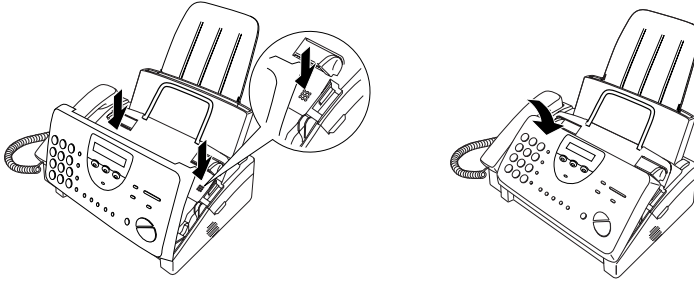

-
- 5** Reinsert the paper in the paper tray and push the paper release plate back down.

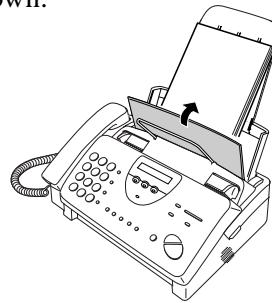

QUICK REFERENCE GUIDE

INSTALLATION

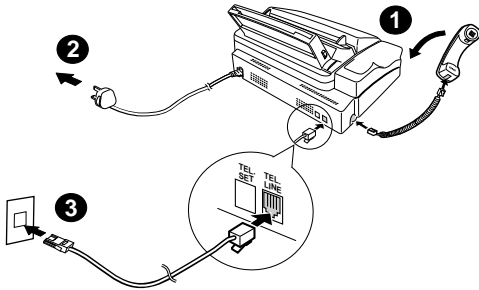

1. Connect the handset as shown.
2. Plug the power lead into an earthed, 230 V outlet.
3. Plug one end of the telephone line into the **TEL. LINE** socket on the rear of the fax, and the other end into your telephone wall socket.

RECORDING AN OUTGOING MESSAGE

1. Press:

Display shows: OGM RECORDING

2. Press:
3. Press **1** (GENERAL) to record an outgoing message for the answering machine. Press **2** (TRANSFER) to record an outgoing message for the Transfer function.
4. Press the **REC/MEMO** key, and then speak facing the **MIC** mark on the lower left corner of the machine at a distance of about 30 cm.
5. When finished, press the **STOP** key or replace the handset.

6. Press:

ENTERING YOUR NAME AND NUMBER

Note: Imaging film and paper must be loaded to perform the following operation.

1. Press:

Display shows: OWN NUMBER SET

2. Press:
3. Enter your fax number (max. of 20 digits) by pressing the number keys.
 - ◆ If you make a mistake, press the **SEARCH/R** key to move the cursor back to the mistake, then enter the correct number or letter.
4. Press:
5. Enter your name by pressing the appropriate number keys as shown below.
 - ◆ To enter two letters in succession that require the same key, press the **SPEAKER** key after entering the first letter.

A =	J =	S =
B =	K =	T =
C =	L =	U =
D =	M =	V =
E =	N =	W =
F =	O =	X =
G =	P =	Y =
H =	Q =	Z =
I =	R =	SPACE =

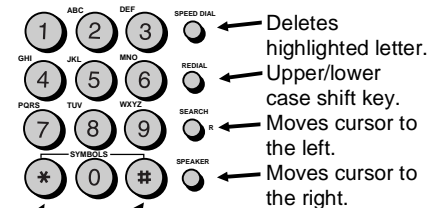

Press either key one or more times to select and enter a symbol.

6. When finished, press:

SETTING THE DATE AND TIME

Note: Imaging film and paper must be loaded to perform the following operation.

Press:     

Display shows: DATE & TIME SET

Press the **START/MEMORY** key: 

Enter two digits for the Day (01 through 31).
 Enter two digits for the Month (01 through 12).
 Enter four digits for the Year (Ex: 1999).
 Enter two digits for the Hour (00 through 23).
 Enter two digits for the Minute (00 through 59).
 When finished, press:

STORING AND CLEARING NUMBERS FOR AUTO DIALLING

Note: Imaging film and paper must be loaded to perform the following operation.

1. Press:   

Display shows: FAX/TEL # MODE

2. Press **1** to store a number or **2** to clear a number.

3. Enter a 2-digit Speed Dial number (from 01 to 05 for Rapid Key Dialling, or 06 to 45 for Speed Dialling). (If you are clearing a number, go to Step 7.

4. Enter the full telephone/fax number.

5. Press: 

6. Enter the name of the location by pressing number keys (max. of 20 characters). (Refer to the letter entry table in ENTERING YOUR NAME AND NUMBER.)



7. Press:  

SENDING DOCUMENTS

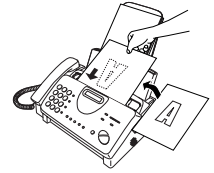
Place your document (up to 10 pages) face down in the document feeder.



Normal Dialling

1. Lift the handset or press  
2. Dial the fax number.
3. Wait for the reception tone (if a person answers, ask them to press their Start key)
4. Press: 

Rapid Key Dialling

Press the appropriate Rapid Key. Transmission will begin automatically.

Speed Dialling

1. Press: 
2. Enter 2-digit Speed Dial number.
3. Press: 

RECEIVING DOCUMENTS

Press: 

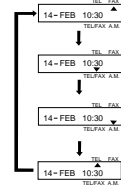

FAX mode: The fax automatically answers and receives the incoming document.

TEL mode:

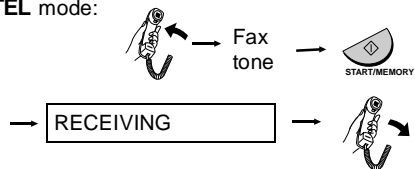

TEL/FAX mode:

The fax machine automatically answers on one ring and receives faxes. Voice calls (including manually dialled fax transmissions) are signalled by a special ringing sound.

A.M. mode: Select this mode when you go out to receive both voice messages and faxes.

Index

A

A.M. Program List, 126
A.M. reception mode, 32, 39, 80
Activity Report, 121
 Automatic printing, 120
Anti junk fax, 105
Anti Junk Fax (Anti Junk Number), 119
Anti Junk Number List, 125
Audible signals, 138
Auto cover sheet, 120
Automatic dialling, 73
Automatic dialling, storing numbers, 70

B

Batch page numbering, 103
Broadcasting, 98

C

Caller ID, 93
Caller ID List, 95
Calling Party Control detection, 45
Chain Dialling, 90
Cleaning, 128, 131
Contrast, 65
Copies, 86
Copy cut-off setting, 88
Copy/Help key, 12, 86
Cover sheet, 120

D

Date, setting, 29
Delete key, 12
Dial mode, 117
Dialling
 Direct Keypad, 75
 Normal, 67, 89
 Rapid Key, 73, 89
 Search, 76, 90
 Speed, 74, 89
Direct Keypad Dialling, 75

Display, 10
Display messages, 136
Document feeder, 63
Document guides, 63
Document restrictions, 62
Document rollers, 131
Document sizes, 61
Document, maximum scanning size, 62

E

Extension telephone
 Connecting, 18
 Using, 82

F

FAX reception mode, 32, 79
Fax reception on A.M. failure, 44
Fax Signal Receive, 118
Fine Resolution Priority, 114
Function key, 11

H

Halftone, 65
Handset, 14
Housing, cleaning, 131

I

Imaging film, loading and replacing, 19
Incoming message time, 43

J

Jams, clearing, 139
Junk Number Check, 119

L

Letters, entering, 27
Line error, 132
Loading printing paper, 24
Loading the document, 63

M

- Memory
 - Sending documents from, 107
 - Substitute reception to, 85
- Message List, 126
- Messages
 - Checking date and time, 42
 - Erasing, 41
 - Listening to, 40
 - Listening to remotely, 54
 - Setting allowed time, 43

N

- Network Services, 91
- Normal Dialling, 67, 89
- Number keys, 11
- Number of rings in auto answer mode, 115

O

- Option Setting List, 124
- Outgoing message, 36
- Override Ringing, 50

P

- Panel release, 11
- Paper jams, clearing, 140
- Passcode List, 124
- Pauses in automatic dialling, 70, 75
- PBX setting (Recall mode), 118
- Phone Plus Services, 91
- Play/Skip key, 10, 40
- Polling, 109 - 111
- Polling key, setting, 119
- Print contrast setting, 25
- Print head, cleaning, 128
- Print Setup List, 127
- Priority Call, 96
- Pseudo ring duration, 117

R

- Rapid Dial keys, 11
- Rapid Key Dialling, 73, 89
- Rec/Memo key, 11
- Recall times, 115
- Recall Wait Interval, 115
- Reception mode
 - A.M. mode, 32, 39, 80
 - FAX mode, 32, 79
 - Setting, 33
 - TEL mode, 32, 81
 - TEL/FAX mode, 32, 78
- Reception mode key, 11, 33
- Reception Ratio setting, 84
- Redial key, 10, 68, 90
- Redialling, 77, 90
- Remote code number, 52
- Remote operations, 52
- Remote Reception Select, 116
- Removing original document, 64
- Repeat key, 10
- Resolution, 65
- Resolution key, 11
- Ringling volume, 35
- Rollers, cleaning, 131

S

- Scanning glass, cleaning, 131
- Search Dialling, 76, 90
- SEARCH/R key, 11, 90
- Sender's name and number, entering, 26
- Speaker key, 11, 34, 67, 89
- Speaker volume, 34
- Speed Dial key, 10, 74, 89
- Speed Dialling, 74, 89
- START/MEMORY key, 12
- Stop key, 12

T

- TEL reception mode, 32, 81
- TEL. LINE jack, 16
- TEL. SET socket, 18
- TEL/FAX reception mode, 32, 78
- Tel/Fax Remote Number, 116
- Telephone line cord, 16
- Telephone Number List, 123
- Telephone, using as, 89
- Time, setting, 29
- Timer List, 123
- Timer operations, 112
- Transaction Report, 127
- Transaction Report Print Select, 116
- Transfer function, 47
- Two-in-one printing, 83

V

- Volume keys, 11, 34

REMOTE OPERATION CARD

The card below is provided as a quick guide to remote operation. Cut it out and carry it with you when you go out.

<p>Remote Operation Guide</p> <ol style="list-style-type: none">1. Call your fax from a touch-tone telephone, and press <input type="text" value="#"/> when the outgoing message begins.2. Enter your remote code: <input type="text" value=""/><input type="text" value=""/><input type="text" value=""/>.3. Press <input type="text" value="#"/>.4. After listening to your messages, you can either hang up to save them, or enter one of the commands on the reverse side.	<p>SHARP®</p>
--------------------------------------------------------------------------------------------------------------------------------------------------------------------------------------------------------------------------------------------------------------------------------------------------------------------------------------------------------------------------------------------------------------------------------------------------------------------------------------------------------------------------------	----------------------

REMOTE COMMANDS

- **PLAYBACK**
 - Play messages 7 #
 - Move backward/repeat 2 #
 - Skip forward 5 #
 - Stop 0 #
 - Play new messages only 6 #
(first stop playback)
- **ERASING MESSAGES**
 - Erase single message 3 #
 - Erase all messages 3 3 #
- **RECORDING A MEMO**
 - Start * #
 - End 0 #
- **RECORDING A NEW OGM**
 - Start 4 *
- **FAX RECEPTION MODES**
 - A.M. mode 8 1 #
 - FAX mode 8 2 #
 - TEL mode 8 3 #
 - TEL/FAX mode 8 4 #
- **TRANSFER FUNCTION**
 - Turn on 9 1 #
 - Turn off 9 2 #
 - New transfer number 9 0 #
→ (Tel.#)
→ #
 - Record transfer OGM 9 3 #
 - To quickly disconnect * *
- **OGM ONLY MODE**
 - Turn on 1 1 #
 - Turn off 1 2 #

SHARP®

SHARP ELECTRONICS (U.K.) LTD.

Sharp House, Thorp Road, Newton Heath, Manchester, M40 5BE

SHARP CORPORATION

PRINTED IN SPAIN
(TINSE3979FFZZ)